

**MEDIUM DUTY BATTERY ELECTRIC
ZERO EMISSION POWERTRAIN OPERATOR MANUAL**

PACCAR
EPOWERTRAIN

Safety	1
E-Powertrain System	2
Indications and Controls	3
E-Powertrain Operations	4
Maintenance	5
Specifications	6
Information	7

© 2024 PACCAR Inc. - All Rights Reserved

This manual illustrates and describes the operation of features or equipment which may be either standard or optional on this vehicle. This manual may also include a description of features and equipment which are no longer available or were not ordered on this vehicle. Please disregard any illustrations or descriptions relating to features or equipment which are not on this vehicle. PACCAR reserves the right to discontinue, change specifications, or change the design of its vehicles at any time without notice and without incurring any obligation. The information contained in this manual is proprietary to PACCAR. Reproduction, in whole or in part, by any means is strictly prohibited without prior written authorization from PACCAR Inc.

Chapter 1 | SAFETY

Using this Manual.....	5
Safety Messages and Notes.....	5
Battery Electric Vehicle (BEV) Safety Labels.....	6
Illustrations.....	13

Using this Manual

Please take the time to get acquainted with your vehicle by reading this Operator's Manual. We recommend that you read and understand this manual from beginning to end before you operate this equipment. This manual contains useful information for the safe and efficient operation of this equipment. It also provides maintenance information, with an outline for performing safety checks and basic preventive maintenance inspections. When replacement parts are needed, we recommend using only genuine PACCAR parts.

We have tried to present the information needed to learn about functions, controls, and operation—and to present it as clearly as possible. Occasionally, you may need to reference this manual, and we hope you find it easy to use.

	NOTE
After you have read this manual, it should be stored in the cab for con-	

venient reference and remain with this vehicle when sold.

Your vehicle may not have all the features or options mentioned in this manual. Therefore, you should pay careful attention to the instructions that pertain to just your vehicle. In addition, if your vehicle is equipped with special equipment or options not discussed in this manual, consult your dealer or the manufacturer of the equipment.

There are several tools built into this manual to help you find what you need quickly and easily; first is the Table of Contents. Located at the front of the manual, this table arranges the subject matter into chapters, which can be quickly referenced using the numbers shown in the outer margin. The first page of each chapter presents a list of the major subjects contained in that chapter. Cross-referenced citations can also help you find information. If more information on the current subject is located elsewhere in the manual, a cross-reference may be provided, such as "see [Safety Messages and Notes](#) on page 5." Finally, you will find a helpful index at the back of the manual which lists the subjects covered alphabetically.

All information contained in this manual is based on the latest production information available at the time of publication. If you find differences between your instruments and the information in this manual, contact an authorized Kenworth or Peterbilt dealer. Kenworth Truck Company and Peterbilt Motors Company reserve the right to make changes at any time without notice.

Safety Messages and Notes

Read and follow ALL safety messages in this manual. When followed, injury to yourself and others, damage to equipment and/or property, or other unknown hazards are reduced. Both safety messages and notes are emphasized using a safety message symbol and one of three signal words: WARNING, CAUTION, or NOTE. **Do not** ignore any of these messages.

Warnings



Safety messages that follow this symbol and signal word provide a warning against operating procedures, actions, or a lack of

action that could result in death or injury. An unheeded warning may also result in damage to equipment, property, or the environment. Warning messages will identify the hazard, how to avoid it, and the probable consequence of not avoiding the hazard.

Example:

 WARNING
<p>DO NOT touch or attempt to remove any of the orange high voltage (HV) cables, connectors, or components for any reason. If asked to inspect HV component or cabling, only inspect visually. Failure to comply may result in death or personal injury.</p>

Cautions



Safety messages that follow this symbol and signal word provide a caution against operating procedures, actions, or a lack of

action that could result in equipment, property, or environmental damage. Caution messages will identify the hazard, how to avoid it, and the probable consequence of not avoiding the hazard.

Example:

 CAUTION
<p>Always use oil and lubricant that meets PACCAR's recommended specifications. Use of oil or lubricants that do not meet the recommended specifications could adversely affect the e-motor or other e-powertrain components. Failure to comply may result in equipment or property damage.</p>

Notes



Messages that follow this symbol and signal word provide important information that, while not safety related, should still be

followed. A note will provide information that may be useful to the reader: clarifying the topic, providing valuable insight into the topic or process, or saving the reader time and effort.

Example:

 NOTE
<p>The charge port LED illuminates solid green when the vehicle is completely charged.</p>

Battery Electric Vehicle (BEV) Safety Labels

Some electric vehicle components contain enough energy to be lethal if used improperly. For this reason, Battery Electric Vehicle (BEV) badges are displayed on both sides of all battery electric trucks. High voltage (HV) labels are also placed near electrical components to warn and inform operators of dangers and precautions.

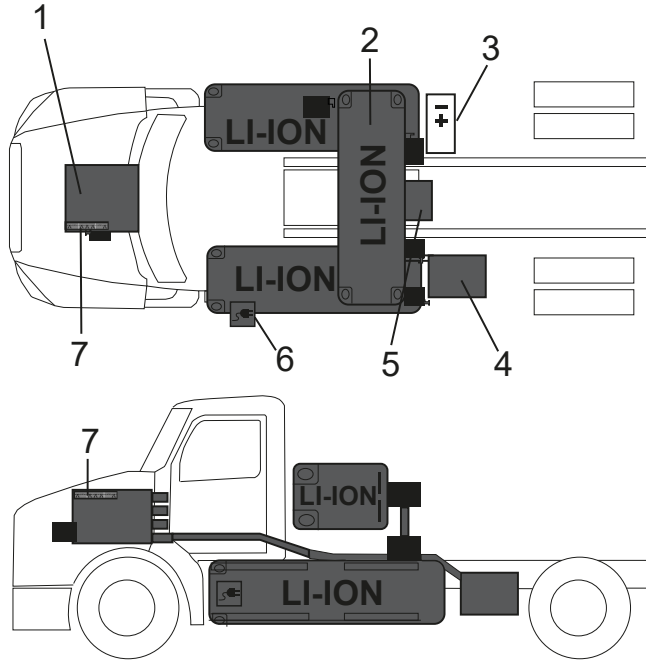
Battery Electric Vehicle (BEV) Layout

1. Power, Controls, and Accessories Systems (PCAS)
2. Optional high-voltage battery locations
3. 12 V disconnect switch
4. E-PTO (optional)
5. E-motor
6. Charge inlet
7. 12 V cut loop

Battery Electric Vehicle (BEV) Badge

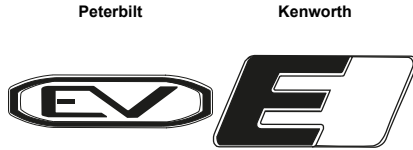

All electric vehicles can be identified by the BEV badge located on the hood. Electric vehicles are powered by high voltage batteries which can be dangerous and toxic. Precautions must be taken while servicing the vehicle.

Labels to show the risks that can be encountered while servicing or walking around this vehicle.

General Safety Labels





General Safety Labels help warn the operator or any other person coming in contact with certain components such as stored energies, liquids, gases, and solids that may be hazardous to health.

BEV Safety Labels

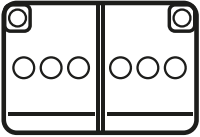
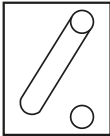

The Battery Electric Vehicle (BEV) Safety Labels are composed of General Safety Labels and high-voltage (HV) Safety

Stored Energy / Liquids / Gases / Solids Labels

Icon	Description
 <p>The icon shows a rectangular battery pack divided into two vertical sections. Each section contains four small circles representing individual cells, for a total of eight cells.</p>	<p>Low-voltage batteries</p>
 <p>The icon shows a cylindrical component with a diagonal line through it, and a small circle below it, representing a 12V disconnect.</p>	<p>12 V disconnect</p>

Icon	Description
	Corrosives
	Gas strut
	Flammable
	Health hazards

1

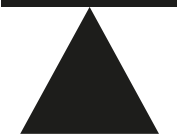
Icon	Description
	Explosion hazard
	Do not use wet foam
	Lithium-ion battery with Thermal Infrared Camera (TIC or IR gun)
	Lift point



Icon	Description
	Compressed air tank

High-Voltage (HV) Safety Labels





The high-voltage (HV) Safety Labels help warn the operator or any other person

coming in contact with the high voltage components as they are highly dangerous. They are placed mainly on the chassis, on electrical components, and on the battery

enclosures. The HV labels come in bright orange to be noticeable for the operator, indicating the amount of electrical charge.

Item	Description
	High voltage (650 V)
	Battery Lithium-ion

1

Item	Description
	Electrocution hazard
	High voltage Lithium-ion battery
	High-voltage cables
	Use water to extinguish Lithium-ion fires

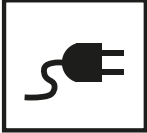
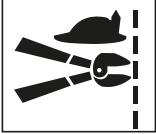
Item	Description
	Master Service Disconnect (MSD)
	Charge inlet
	Battery Electric Vehicle (BEV) 12 V cut loop

Illustrations

Some of the illustrations found in this manual are generic. They will not look exactly like the parts or assemblies you find installed on the vehicle.

When an illustration differs from what you see physically present on the vehicle, the language describing the procedure is still correct for the application.

Chapter 2 | E-POWERTRAIN SYSTEM

Battery Electric Vehicle (BEV) Zero Emissions Powertrain.....	15
Battery Electric Vehicle (BEV) Components.....	15
Battery Management System (High Voltage).....	16
Energy Storage System.....	21
Charging Management System.....	24
Thermal Management System.....	26
Electric Traction Motor System (High Voltage).....	29

Battery Electric Vehicle (BEV) Zero Emissions Powertrain



This zero emissions powertrain vehicle fully meets the California standards and test procedures for medium duty zero emissions powertrain which contains the requirements necessary for criteria pollutants, and greenhouse gas certification of a medium duty electric powertrain used in medium duty vehicles in California.

Zero emissions powertrain vehicles use batteries that are charged before usage from an electricity source and discharged during vehicle operation, creating a cycle of charging. The powertrain and other components require different operating procedures and service intervals than the traditional diesel-powered vehicles.

Battery Electric Vehicle (BEV) Components

The electric vehicle systems can be categorized in the following operation groups:

Battery Electric Vehicle (BEV) Main Power Components

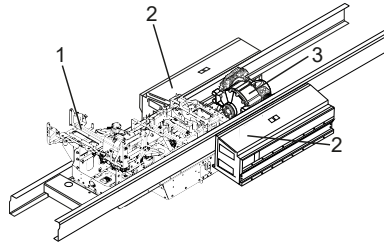

1. Power, Controls, and Accessories Systems (PCAS)
2. High voltage (HV) battery strings
3. E-motor

Power Control and Auxiliary Systems (PCAS)

The Power Control and Auxiliary Systems (PCAS) is located under the hood and under the cab. The PCAS includes the radiator, the compressor, the power steering fluid reservoir, the thermal components to regulate the vehicle systems temperature, the electric components like the DC converter that transforms the high voltage into low voltage.

E-Motor

The electric-drive motor connects to the HV battery string through additional control devices, like the High Voltage Junction Box (HVJB), and when connected, they make up the e-powertrain. The transmission and gear reduction are also located here.

High-Voltage (HV) Battery String

These batteries are the main high-voltage source of power for the vehicle. These HV battery strings are mounted to the frame; the optional battery string is mounted behind the cab. Each group of battery strings has a specific harness routing.

Thermal Components

These components are in the PCAS which integrate the cooling system and are used to maintain the temperature of e-motor, batteries, and cab.

The thermal components include the following:

- Battery coolant circuit
- Power electronics coolant circuit

Refer to [Thermal Management System](#) on page 26 to see more information of thermal components.



WARNING

Electric vehicles utilize a high-voltage electrical system that has the potential to cause severe injury or death if proper safety precautions are not followed. Carefully read and understand all in-

structions and hazard alert messages. Failure to comply may result in death, personal injury, equipment damage, or property damage.

Battery Management System (High Voltage)



WARNING

DO NOT touch any part of the high-voltage electrical system or its components. They are high voltage and you could receive an electric shock. Failure to comply may result in death, personal injury, equipment damage, or property damage.

The battery system consists of two (standard) to three (optional) battery strings connected in parallel to the S-box. This vehicle is equipped with a 650 V battery system and a relay box which is connected in series to achieve the vehicle level voltage and meet the vehicle energy and power requirements.

The Battery Management System (BMS) monitors the batteries charge level, health,

temperatures, and more. The BMS also maintains proper battery balancing. The BMS includes the following:

- Relay box
- S-box

Battery Gauge and Estimated Range

The Battery Management System (BMS) monitors the State of Charge (SOC) of the High-Voltage (HV) batteries and notifies the operator of the need to get the vehicle to a safe location and charge the vehicle when necessary. The battery gauge has two locations: on the top bar and either to the left of or below the speedometer and indicates the nominal battery state; the fill color can be either blue or red (when low SOC). In the center of the display, the estimated range bar shows the estimated distance the vehicle can be driven before it runs out of power. This estimated range is calculated by several factors such as loading weight and driving style. When the SOC decreases to a critically low state, the estimated range number disappears from the display to signal the need to get to a charger soon.

The system alerts the operator with non-suppressible warnings on the Digital

Display when the battery level of the vehicle is decreasing. When the battery reaches a critically low state, there is a power derate that prevents the vehicle from accelerating quickly and reduces the top speed. See [Charging Considerations](#) on page 46.

Nominal Battery State



When the SOC is at optimal state, the color of the indicator at the top bar and the gauge in the center of the Digital Display remains blue. Low power location is represented by a red line across the blue gauge.

Pre-Warning



When the SOC decreases and reaches 25%, the red line indicating the low power zone in the SOC gauge in the center of the display becomes a red zone, but the SOC indicator at the top bar remains blue.

Low SOC Warning

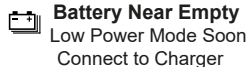

When the SOC decreases to 20%, both the SOC indicator and the SOC gauge turn red. The vehicle also starts an audible and a visual notification of **Battery Near Empty**, indicating that the SOC is decreasing and that the vehicle needs to be connected to a charger.

Critical SOC Warning

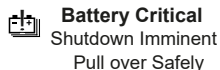

When the SOC continues decreasing, the display shows another notification stating **Battery Critical**, indicating that the vehicle needs to be stopped and that it will shutdown. The estimated range is hidden too, as it becomes difficult to estimate vehicle range as the battery runs out.

Vehicle Shutdown

At 0% SOC the vehicle will shutdown to prevent damage.

Battery Balancing

Battery balancing happens continuously anytime the start switch is ON. The battery management system can most accurately measure battery balance at the top of the State of Charge (SOC) and the bottom of the SOC window so the battery management system knows how much adjustment is needed for each cell. It is important to fully charge or fully discharge periodically for the SOC, State of Health (SOH), and balancing to calibrate.

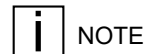

When the vehicle is about to be fully discharged, make sure to be near an EV charger or where is safe to park and have access to a charger.

Relay Box

The relay box is designed to de-energize the battery string when the vehicle is powered off. When parked, but turned on, the batteries are energized.

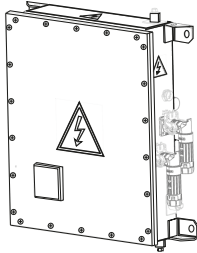

WARNING

DO NOT touch the relay box that is located on each of the battery strings. The relay box is a high voltage component and you could receive an electric shock. Failure to comply may result in death, personal injury, equipment damage, or property damage.



WARNING

DO NOT touch any part of the high-voltage electrical system or its components. They are high voltage and you could receive an electric shock. Failure to comply may result in death, person-

al injury, equipment damage, or property damage.



WARNING

DO NOT attempt to service this vehicle. Only an EV service certified dealership is authorized to service a PAC-CAR electric vehicle (EV). EVs use high voltage, posing additional hazards not present when servicing a conventional vehicle. Servicing high voltage components requires proper training, tools, and equipment. **Visual inspections are the only tasks that should be performed by the operator.** Failure to comply may result in death, personal injury, equipment damage, or property damage.

Master Service Disconnect (MSD)

A Master Service Disconnect (MSD) is located on each relay box and all must be pulled by an EV service certified dealership anytime service is required.

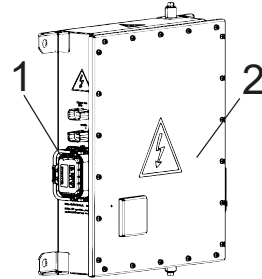

1. Master Service Disconnect (MSD)
2. Relay box



WARNING

DO NOT open the high-voltage battery enclosure for any reason. The battery packs are part of the high-voltage system and do not contain operator-serviceable items. Please contact or take the vehicle to an authorized EV service certified dealership for service. Failure to comply may result in death, personal injury, equipment damage, or property damage.

**WARNING**

The Master Service Disconnect (MSD) needs to be pulled only by an EV service certified dealership. Failure to comply may result in death, personal injury, equipment damage, or property damage.

S-Box

The S-box combines power from each battery string and sends the power to the High Voltage Junction Box (HVJB). The S-box also contains a Master Battery Management Unit (BMU), output fuses, and main contactors.

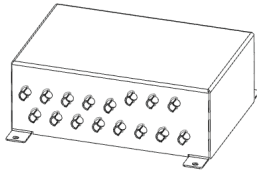
**WARNING**

DO NOT touch any part of the high-voltage electrical system or its components. They are high voltage and you could receive an electric shock. Failure to comply may result in death, personal injury, equipment damage, or property damage.

**WARNING**

DO NOT attempt to service this vehicle. Only an EV service certified dealership is authorized to service a PAC-CAR electric vehicle (EV). EVs use high voltage, posing additional hazards not present when servicing a conventional vehicle. Servicing high voltage components requires proper training, tools, and equipment. **Visual inspections are the only tasks that should be performed by the operator.** Failure to comply may result in death, personal injury, equipment damage, or property damage.

Slave Battery Management Unit (BMU)

The slave Battery Management Unit (BMU) is located in each relay box. The slave BMU performs different functions from the master BMUs. The slave BMU is designed to provide communication to the master BMU, contactor control and diagnostics, State of Charge (SOC) and a State of Health (SOH) estimation, current monitoring, battery heating management, Cell Supervisory Circuit (CSC) management, and other battery system functions.

High Voltage Junction Box (HVJB)

The High Voltage Junction Box (HVJB) controls the high voltage connections for all high voltage powered components such as the e-motor, cooling fans, e-air compressor, (2x) e-refrigerant compressor, coolant heater, high pressure power steering pump, etc.

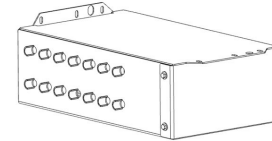



WARNING

DO NOT touch any part of the high-voltage electrical system or its components. They are high voltage and you could receive an electric shock. Failure to comply may result in death, personal injury, equipment damage, or property damage.



WARNING

DO NOT attempt to service this vehicle. Only an EV service certified dealership is authorized to service a PAC-CAR electric vehicle (EV). EVs use high voltage, posing additional hazards not present when servicing a conventional vehicle. Servicing high voltage components requires proper training, tools, and equipment. **Visual inspections are the only tasks that should be performed by the operator.** Failure to comply may result in death, personal injury, equipment damage, or property damage.

Master Battery Management Unit (BMU)

The Master Battery Management Unit (BMU) is located in the S-box and is designed to provide communication between the vehicle and battery strings, management of the relay boxes, main contactor control and diagnostic, fuse diagnostic, and other functions of the battery management system.

DC-DC Converter

The DC-DC converter transforms high voltage (650 V) to low voltage (12 V) DC to power controllers, lights, and other components of the vehicle. The power for 12 V is 3.75 kW.

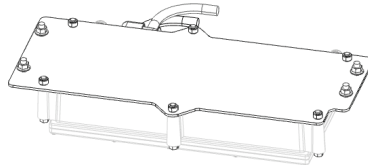

Equipotential Bonding

Equipotential bonding intentionally joins conductive parts of the high voltage system to the same electrical potential through the

use of cables, straps, and bus bars. The system is recognizable by the green-yellow color combination. The vehicle continuously monitors the high voltage system to ensure it is isolated from the chassis. The bonding system must be intact for the isolation monitoring to work properly.



WARNING

DO NOT touch any part of the high-voltage electrical system or its components. They are high voltage and you could receive an electric shock. Failure to comply may result in death, personal injury, equipment damage, or property damage.

**WARNING**

DO NOT attempt to service this vehicle. Only an EV service certified dealership is authorized to service a PAC-CAR electric vehicle (EV). EVs use high voltage, posing additional hazards not present when servicing a conventional vehicle. Servicing high voltage components requires proper training, tools, and equipment. **Visual inspections are the only tasks that should be performed by the operator.** Failure to comply may result in death, personal injury, equipment damage, or property damage.

Energy Storage System

The energy storage system consists of many individual battery cells organized into banks that are inside the batteries and are used to store energy. When driving the vehicle, energy is drawn from the bank, which means energy is drawn from all cells. However, different cells within the

bank can have differing energy levels. See [Cells](#) on page 22. The energy storage system consists of the battery strings and the low voltage battery box.

High Voltage (HV) Battery String

The high voltage (HV) battery string contains two batteries, connected in series, and a relay box. Each HV battery string supplies 650 V, with a capacity of 228 Ah, and a nominal energy of 141 kWh. The components of an HV battery string include:

- Two high-voltage batteries
- Relay box
- Cell Supervisory Circuit (CSC)

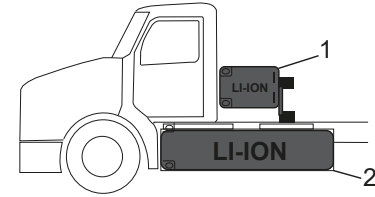
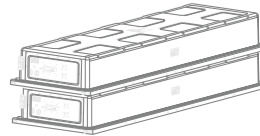

1. HV battery string location (optional)
2. HV battery string location

**NOTE**

The high-voltage batteries contain a circuit that monitors the temperature of the batteries and reports it to the vehicle. The vehicle controls the temperature and flow of coolant to the battery packs to maintain operating temperatures.



WARNING

If any issues involving the high-voltage electrical system are discovered, DO NOT drive the vehicle. Please contact or take the vehicle to an authorized EV service certified dealership for service. Failure to comply may result in death, personal injury, equipment damage, or property damage.



WARNING

DO NOT open the high-voltage battery enclosure for any reason. The battery packs are part of the high-voltage system and do not contain operator-serviceable items. Please contact or take the vehicle to an authorized EV service certified dealership for service. Failure to comply may result in death, personal injury, equipment damage, or property damage.

Lithium-Iron Phosphate Battery

Each battery contains 96 lithium-iron phosphate cells that all combined supply 309 V, with a capacity of 228 Ah, and an

energy of 70.4 kWh. See [Cells](#) on page 22 for the characteristics of the cells.

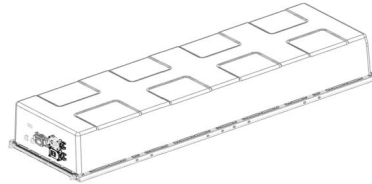

WARNING

DO NOT open the high-voltage battery enclosure for any reason. The battery packs are part of the high-voltage system and do not contain operator-serviceable items. Please contact or take the vehicle to an authorized EV service certified dealership for service. Failure to comply may result in death, personal injury, equipment damage, or property damage.

Cells

The cells are inside the batteries and are used to store energy. The battery packs utilize lithium iron phosphate cells that are

placed on an integrated cooling plate, which is used to lower the cell temperature. Once a single cell in the bank is completely empty, the vehicle considers the bank empty. When charging the vehicle as quickly as possible, the vehicle will show to be fully charged when a single cell in the bank is completely full. A few considerations must be taken to maintain the best durability of the batteries. See [Charging Considerations](#) on page 46.

Lithium Iron Phosphate Cell

Number of Cells	Voltage (V)	Capacity (Ah)	Nominal Energy (Wh)
1	3.22	228	734

Lithium Iron Phosphate Cells per Each Battery String

Number of Cells	Voltage (V)	Capacity (Ah)	Energy (kWh)
192	650	228	141



WARNING

DO NOT touch any part of the high-voltage electrical system or its components. They are high voltage and you could receive an electric shock. Failure to comply may result in death, personal injury, equipment damage, or property damage.



WARNING

DO NOT open the high-voltage battery enclosure for any reason. The battery packs are part of the high-voltage system and do not contain operator-serviceable items. Please contact or take

the vehicle to an authorized EV service certified dealership for service. Failure to comply may result in death, personal injury, equipment damage, or property damage.

Cell Supervisory Circuit (CSC)

The Cell Supervisory Circuit (CSC) is a circuit that monitors cell temperatures and voltages in each battery to perform a cell balancing.

State of Charge (SOC)

The State of Charge (SOC) is used to determine how much energy is stored in the battery. This value is used to calculate the remaining range estimates for the operator.

Every time the vehicle undergoes a deep discharge (below 25% or so) or reaches 100% charge, the Battery Management System (BMS) automatically calibrates the SOC. During normal operation, the vehicle monitors the energy flowing into and out of the batteries and adjusts the SOC in real time. See [Battery Balancing](#) on page 17. See [High-Voltage Batteries](#) on page 59 for the SOC tasks and maintenance intervals.



WARNING

DO NOT attempt to diagnose or correct any vehicle issues related to the high-voltage electrical system or components. Please contact or take the vehicle to an authorized EV service certified dealership for service. Attempting to diagnose or correct vehicle issues may result in death, personal injury, equipment damage or property damage

State of Health (SOH)

The State of Health (SOH) is used to determine how much of the original battery capacity is still usable. The SOH is impacted by both cyclic use (charging and discharging the battery) and time. The Battery Management System (BMS) monitors both cyclic use of the battery and the age of the battery, then the BMS adjusts the state of health accordingly. However, to ensure the state of health measurement is accurate, an annual SOH calibration is required. See [High-Voltage Batteries](#) on page 59 for the SOH tasks and maintenance intervals.



WARNING

DO NOT attempt to diagnose or correct any vehicle issues related to the high-voltage electrical system or components. Please contact or take the vehicle to an authorized EV service certified dealership for service. Attempting to diagnose or correct vehicle issues may result in death, personal injury, equipment damage or property damage.

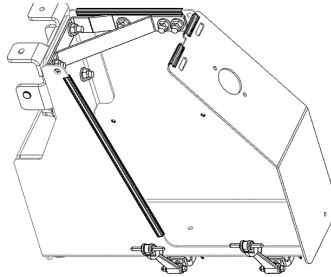

personal injury, equipment damage, or property damage.



WARNING

DO NOT open the high-voltage battery enclosure for any reason. The battery packs are part of the high-voltage system and do not contain operator-serviceable items. Please contact or take the vehicle to an authorized EV service certified dealership for service. Failure to comply may result in death, personal injury, equipment damage, or property damage.

Low-Voltage Battery Box

The low-voltage battery box contains two 12 V batteries and the disconnect switch. The low-voltage battery box also includes a low-voltage distribution circuit that is covered by a full steel box with aluminum cover. Refer to [Low Voltage Batteries](#) on page 71 for low-voltage battery charging guidance.



WARNING

If any issues involving the high-voltage electrical system are discovered, DO NOT drive the vehicle. Please contact or take the vehicle to an authorized EV service certified dealership for service. Failure to comply may result in death,

Charging Management System

The charging system includes the following components:

- Charge Inlet (CI)¹
- On-Board Charger (OBC) (optional)
- Charge Control Unit (CCU)

Charge Inlet (CI)

The Charge Inlet (CI) is where the operator plugs the charger into the vehicle. The CI is located on the driver's side and uses a CCS type 1 charger inlet. The CCS type 1 charger inlet is a common charger inlet in the electric vehicle industry and it features both an AC inlet and a DC fast charge inlet.

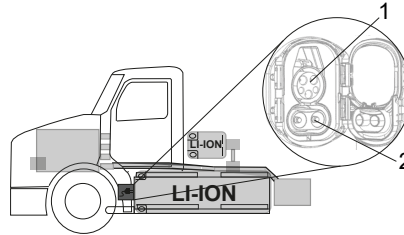

1. AC charge inlet (≤ 22 kW)
2. DC fast charge inlet (≤ 350 kW)

When the vehicle is charging, the State of Charge (SOC) can be monitored at the charge port LED. See [Initiating a Charge](#) on page 45 for further information on the charging operation.

On-Board Charger (OBC) (Optional)

The On-Board Charger (OBC) is an optional component that accept AC chargers. The OBC converts the input AC power to DC power to fully charge the high-voltage batteries. Vehicles not equipped with the OBC can only charge using DC chargers.

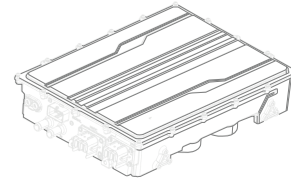

Charge Control Unit (CCU)

The Charge Control Unit (CCU) is a controller that does not bypass the On-Board Charger (OBC). This device facilitates the communication between the vehicle and the charger. This device is necessary regardless of if the vehicle is AC or DC charging.

¹ The Charge Inlet (CI) includes LEDs that indicates the status of the charging process.

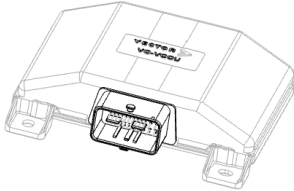

Thermal Management System

The thermal management system is responsible for maintaining the e-motor, e-powertrain components, and the batteries at an optimum temperature while driving. The thermal management system is divided into two coolant circuits: Battery Coolant Circuit and Power Electronics Coolant Circuit. Two coolant reservoirs per each thermal circuit distribute the coolant to the vehicle systems.

Battery Coolant Circuit

The function of the battery coolant circuit is to keep the batteries within the proper operating temperatures. The battery coolant circuit box is located between the frame rails. This circuit uses the following components listed below:

- Chiller
- Coolant pump
- Internal battery coolant tubes
- Electric resistive heating elements inside the batteries
- Surge tank
- Manifolds
- Mounting brackets and enclosure

Power Electronics Coolant Circuit

The power electronics coolant circuit supplies coolant to the e-motor, power electronics, and other components that need to be within proper operating temperatures. The power electronics coolant circuit tank is located within the Power, Controls, and Accessories Systems (PCAS) assembly.

Power Electronics Coolant Circuit Components

1. Power electronics coolant surge tank²
2. Coolant vent hose
3. High-voltage cabin coolant heater
4. Heat exchanger coolant hose, source
5. Heat exchanger coolant hose, return

² No other component of the system except the power electronics coolant surge tank should be touched by the operator.

Power Electronics Coolant Surge Tank Components

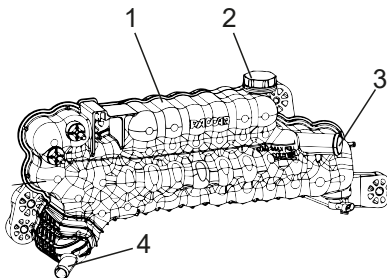

1. Power electronics coolant surge tank
2. Coolant fill cap
3. Coolant draw-down outlet
4. Coolant vent outlet

Electric Refrigerant Compressor (High Voltage)

Two electric refrigerant compressors provide high pressure and high temperature refrigerant to the thermal management systems to maintain the optimum temperature of the cabin and the batteries.

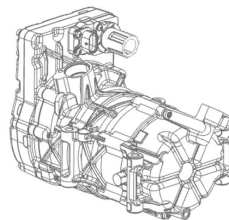

WARNING

DO NOT touch any part of the high-voltage electrical system or its components. They are high voltage and you could receive an electric shock. Failure to comply may result in death, personal injury, equipment damage, or property damage.



WARNING

DO NOT attempt to diagnose or correct any vehicle issues related to the high-voltage electrical system or components. Please contact or take the vehicle to an authorized EV service certified dealership for service. Attempting to diagnose or correct vehicle issues may result in death, personal injury, equipment damage or property damage.

E-Fan

The e-fan is controlled by the main powertrain control unit. Whether the fan is ON or OFF the speed of the fan can be impacted by multiple things including refrigerant pressures and coolant temperatures. To maintain an optimum performance and durability of the e-fan, maintenance tasks must be performed. See [E-Fan \(High Voltage\)](#) on page 58 for the e-fan tasks and maintenance intervals.

**WARNING**

DO NOT wear loose-fitting or torn clothing, jewelry or accessories, or loose hairstyles. Loose or dangling materials can get caught in fan blades or other moving parts. Failure to comply may result in death, personal injury, equipment damage, or property damage.

**WARNING**

DO NOT attempt to diagnose or correct any vehicle issues related to the high-voltage electrical system or components. Please contact or take the vehicle to an authorized EV service certified dealership for service. Attempting to diagnose or correct vehicle issues may result in death, personal injury, equipment damage or property damage.

**WARNING**

Ensure any modifications to the vehicle DO NOT affect the high-voltage system. A modification could affect the high voltage electrical system, resulting in electric shock, burns or even death, and will void the warranty. Failure to comply may result in death, personal injury, equipment damage, or property damage.

TXV-Chiller

The TXV-Chiller is a combination of a thermal expansion valve and a coolant-to-refrigerant heat exchanger. The thermal expansion valve causes incoming refrigerant to rapidly decrease in pressure and temperature. The heat exchanger allows the hot coolant to transfer its heat to the cold refrigerant. The function of the TXV-chiller is to maintain the maximum battery operation temperature threshold by circulating chilled coolant through the high-voltage batteries.

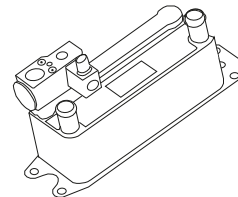
**Coolant Heater**

The coolant heater heats the coolant when needed for cabin occupant comfort. During normal driving conditions, the vehicle uses waste heat from the electric propulsion motor to heat the cab. The coolant heater is only used when the cabin heat demand is higher than what the propulsion motor can provide. This most commonly occurs during start-up or stop-and-go driving in cold weather.

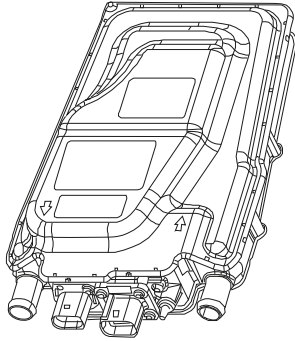

Proportional Coolant Valve

The proportional coolant valve has a high actuation count to maintain optimal temperature for efficient cabin heating at low ambient temperature.

Cab Pump

In the cab loop, a high-voltage heater heats the coolant used in the heating of the cab. The high-voltage heater requires a great amount of water going through to prevent local boiling.

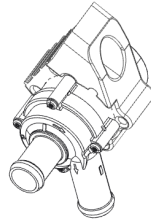

Electric Traction Motor System (High Voltage)

The electric traction motor system is one assembly about the size of a standard 18-speed transmission that consists of two e-motors, two inverters, two shift actuators, an oil pump, a gearbox, and an oil to water heat exchanger.

WARNING

DO NOT touch any part of the high-voltage electrical system or its components. They are high voltage and you could receive an electric shock. Failure

to comply may result in death, personal injury, equipment damage, or property damage.

WARNING

DO NOT attempt to service this vehicle. Only an EV service certified dealership is authorized to service a PAC-CAR electric vehicle (EV). EVs use high voltage, posing additional hazards not present when servicing a conventional vehicle. Servicing high voltage components requires proper training, tools, and equipment. **Visual inspections are the only tasks that should be performed by the operator.** Failure to comply may result in death, personal injury, equipment damage, or property damage.

E-Motor

The e-motors include integrated inverters that deliver high continuous power and an efficient output torque. The e-motors are also equipped with e-actuators and incorporates an Electronic Control Unit (ECU). Only EV service certified dealership

should perform maintenance tasks. Please refer to *E-Motor (High Voltage)* on page 58 section for e-motor tasks and maintenance intervals.

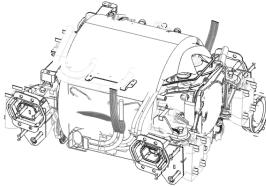

NOTE

Coolant temperature sensors divert the hot coolant produced by the e-motor to the cab, allowing the wasted heat to be used to heat the cab during the activation of the HVAC.



WARNING

DO NOT tow the vehicle with the driveshaft connected to avoid generating electricity from the Permanent Magnet Synchronous Motor (PMSM). If the vehicle needs to be towed, either remove the driveshaft or lift the rear wheels.

Failure to comply may result in death, personal injury, equipment damage, or property damage.



WARNING

DO NOT attempt to diagnose or correct any vehicle issues related to the high-voltage electrical system or components. Please contact or take the vehicle to an authorized EV service certified dealership for service. Attempting to diagnose or correct vehicle issues may result in death, personal injury, equipment damage or property damage.



WARNING

Ensure any modifications to the vehicle DO NOT affect the high-voltage system. A modification could affect the high voltage electrical system, resulting in electric shock, burns or even death, and will void the warranty. Failure to comply may result in death, personal injury, equipment damage, or property damage.



NOTE

The vehicle displays an e-motor icon when software updates related to the e-motors, controllers, oil pump, and other devices are available. When this occurs, contact PACCAR service to receive the proper guidance to service the vehicle by an authorized PACCAR center.

E-Motor Shift Transmission

The e-motor system has a 4-speed transmission that has three forward gears and one reverse gear. The e-motor system shifts through the three forward gears automatically when the operator is driving the vehicle.

Regenerative Braking System

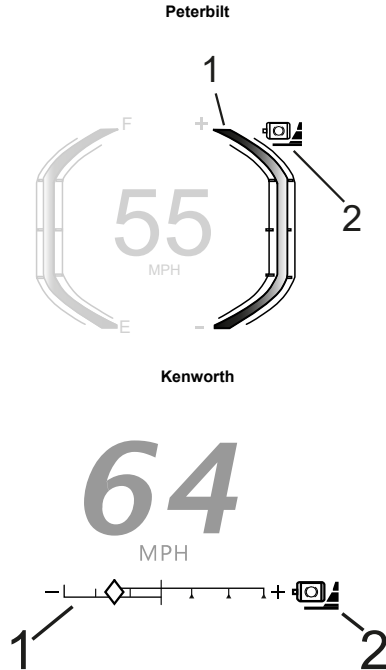

1. Power Meter
2. Regenerative Braking indicator

The e-motor produces power for the batteries when the vehicle is in regenerative mode, acting as a generator. The Regenerative Braking System (RBS) automatically decelerates the vehicle when the accelerator pedal is released and the vehicle is moving. Regenerative Braking adds power back into the battery, extending the driving range.



WARNING

Charging the vehicle to 98% or higher disables regenerative braking until the State of Charge (SOC) is below 98%. **In situations where regenerative braking is disabled, rely on the service brakes to slow or stop the vehicle.** Failure to comply may result in death, personal injury, equipment damage, or property damage.





NOTE

The regen icon turns gray and the regen gauge has three amber bars to indicate the deactivation of the regenerative braking system due to the battery State of Charge (SOC) being near full charge.

The Regenerative Braking system contains four levels:

- Regenerative Level OFF
- Regenerative Level 1
- Regenerative Level 2
- Regenerative Level 3

Position	Amount of Regen Braking	Indicator Shown on Digital Display
OFF	0%	

Position	Amount of Regen Braking	Indicator Shown on Digital Display
1	33%	
2	66%	
3	100%	

Moving the stalk clockwise will activate the Regenerative Braking feature. Increase the amount of Regenerative Braking by moving the stalk further clockwise. Each position has a corresponding level of this feature:

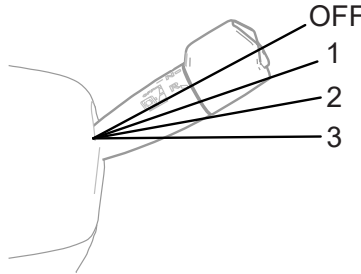

The Level Bars always correspond to the selection on the Right Hand Stalk Shifter (RHSS). The colors of each bar segment also indicate that level's state:

- Light grey: available but not selected.
- White: available and selected.
- Amber outline: degraded performance but not selected.
- Amber: degraded performance and selected.

Degraded Regenerative Braking

When the Battery Management System is unable to receive power from the Regenerative Braking System, some of the levels will have degraded performance. For example, if the battery is mostly full, you may only be able to select and use Level 1, even though you can still use the RHSS to select Levels 2 and 3. This is visually reflected in the Digital Display in both the Indicator bars being shown in amber, and amber segments appearing in the Power Gauge where the regen bar normally shows regen braking occurring. During degraded regen braking, use your service brakes to safely maintain speed.

Regenerative Braking Operation

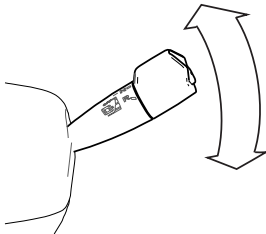

Regenerative Braking Indicator

The indicator shown on the Digital Display is made up of two parts: The brake/motor symbol and the Level Bars.

The brake/motor symbol indicates when the system is enabled and if it is actively storing energy:

- White: enabled and available to use.
- Green: actively storing energy (regen braking).
- Dark grey: not available.

Regenerative Braking Unavailable

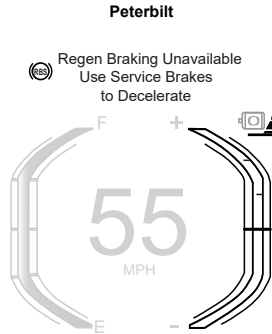

Kenworth

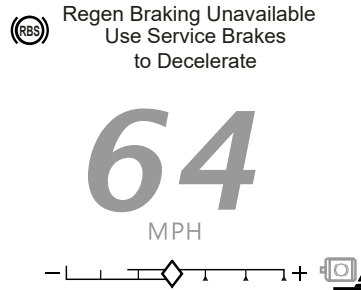

If the regenerative braking system is unavailable, the driver receives a notification, and service brakes must be applied to slow down the vehicle.

Regenerative Braking Fault



When a fault in the regenerative braking system occurs, an RBS indicator is shown along with a pop-up notification. See [Regenerative Braking System \(RBS\) Fault](#) on page 40.



WARNING

Charging the vehicle to 98% or higher disables regenerative braking until the State of Charge (SOC) is below 98%. **In situations where regenerative braking is disabled, rely on the service brakes to slow or stop the vehicle.** Failure to comply may result in death, personal injury, equipment damage, or property damage.



NOTE

The regen icon turns gray and the regen gauge has three amber bars to indicate the deactivation of the regenerative braking system due to the battery State of Charge (SOC) being near full charge.

2

Inverter

The inverter is in communication with the vehicle controllers, and transforms DC voltage to AC voltage needed to power the e-motors.

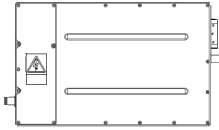

Chapter 3 | INDICATIONS AND CONTROLS





3

Warning Lights and Indicators.....	37
Dash Switches.....	41
Right-Hand Stalk.....	42







Warning Lights and Indicators

instrument cluster. Each indication in this table has a unique name, symbol, and lists the illuminated color or colors.

The following table lists the warning lights and indicators that appear on the

Symbol	Indicator	Color
	<i>12 V Battery</i> on page 38	Amber/red ³
	<i>Charge Plug Connected</i> on page 39	Green
	<i>High-Voltage Hazard</i> on page 39	Red
	<i>Low-Voltage Disconnect (LVD)</i> on page 39	Amber
	<i>Move Disallowed</i> on page 40	Amber

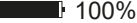
³ Amber color indicates a low-voltage condition and red color indicates a high or very low-voltage condition.

Symbol	Indicator	Color
	<i>Ready to Move</i> on page 40	Green
	<i>Regenerative Braking</i> on page 40	Green
	<i>Regenerative Braking System (RBS) Fault</i> on page 40	Amber
	<i>Service Vehicle</i> on page 41	Amber
	<i>State of Charge (SOC)</i> on page 41	Blue/green/red/white ⁴
	<i>Stop Charging</i> on page 42	Green

12 V Battery



The 12 V battery indicator shows the battery icon, voltage, and the state of charge. The battery icon illuminates amber to indicate a low-voltage condition and

⁴ Blue color indicates default/not charging, green color indicates charging, red color indicates low SOC and white color indicates plugged and waiting for scheduled charge to start.

illuminates red to indicate a high or very low-voltage condition. The Low-Voltage Disconnect (LVD) icon replaces the battery icon when the LVD is active. Refer to [Low-Voltage Disconnect \(LVD\)](#) on page 39 for more specifications of Low-Voltage Disconnect (LVD).

Charge Plug Connected



This indicator illuminates on the top bar of the Digital Display when the vehicle's charge inlet is plugged into a charger. The Move Disallowed symbol that states **Unplug Charger** will be displayed on the Digital Display if the driver attempts to drive the vehicle while the vehicle is still plugged into the charger. Refer to [Move Disallowed](#) on page 40 for more specifications of the Move Disallowed feature.

 CAUTION
<p>DO NOT attempt to drive off if the vehicle is charging as this could damage the charging inlet. Ensure the charging</p>

cord is not connected and the Ready to Move indicator is illuminated on the Digital Display. Failure to comply may result in equipment or property damage.

High-Voltage Hazard



This warning light illuminates when there is a high-voltage hazard that may be caused by a broken high-voltage interlock loop, low isolation resistance, or other failures in the high-voltage electric powertrain system. If this warning light illuminates, find a safe place to pull over, shutdown the vehicle, and call an EV service certified dealership for assistance.

 WARNING
<p>DO NOT attempt to diagnose or correct any vehicle issues related to the high-voltage electrical system or components. Please contact or take the vehicle to an authorized EV service certified dealership for service. At-</p>

tempting to diagnose or correct vehicle issues may result in death, personal injury, equipment damage or property damage.

 WARNING
<p>DO NOT touch or attempt to remove any of the orange high voltage (HV) cables, connectors, or components for any reason. If asked to inspect HV component or cabling, only inspect visually. Failure to comply may result in death or personal injury.</p>

Low-Voltage Disconnect (LVD)



This indicator illuminates amber accompanied by an audible warning when the battery voltage drops below the LVD setting. This starts the two-minute countdown.

Move Disallowed



The Move Disallowed indicator is displayed on the Digital Display in amber color when the vehicle is not able to move under its own power. This can occur because the battery SOC is too low, because the charge plug is attached, or because the transmission is not in Neutral on start up. There are four requirements that need to be satisfied in order to put the vehicle in motion:

- Shift to neutral
- Unplug charger
- Apply brake pedal
- Set parking brake

Ready to Move



The ready to move indicator helps the operator to know when it is safe to start driving, as the vehicle does not emit any audible signal. The ready to move symbol turns ON in the following conditions:

- When the vehicle changes from Parking or Neutral and starts to move with the brake pedal applied.
- After the charger is unplugged and the vehicle is in Drive or Reverse mode with the brake pedal applied.

This symbol turns OFF once the vehicle has started moving, and returns when is parked with the Start switch in the ON position.

 WARNING
<p>Vehicle noise may be reduced in some operation modes. The vehicle operator must remain aware of nearby vehicles or pedestrians at all times. Failure to comply may result in death, personal injury, equipment damage, or property damage.</p>

Regenerative Braking



The Regenerative Braking indicator is located in the center of the Digital Display and turns green when active and white when inactive. The three bars indicate the

current position of the Right Hand Stalk Shifter setting. It can also indicate limitations of the regenerative system when the icon shows the bars outlined and amber. See [Regenerative Braking System](#) on page 31 for the specific operation of this feature.

Regenerative Braking System (RBS) Fault



The Regenerative Braking System (RBS) fault indicator is displayed when the brake system experiences a fault condition that disables the RBS function. When this warning light appears, brakes must be applied manually to slow down the vehicle.

 NOTE
<p>The regen icon turns grey and the regen gauge has three amber bars to indicate the deactivation of the regenerative braking system due to the battery State of Charge (SOC) being near full charge.</p>

Service Vehicle



This warning light illuminates when the vehicle needs to be serviced or permanent damage may occur.



WARNING

DO NOT attempt to diagnose or correct any vehicle issues related to the high-voltage electrical system or components. Please contact or take the vehicle to an authorized EV service certified dealership for service. At-

tempting to diagnose or correct vehicle issues may result in death, personal injury, equipment damage or property damage.

- White: plugged in to charger and waiting for scheduled charge to start

State of Charge (SOC)



100%

The State of Charge (SOC) or charge status shows the level of charge of the high-voltage batteries, shown as a percentage.

- Blue: default/not charging
- Green: charging
- Red: low SOC

Dash Switches

Vehicles may not have every switch identified in this section of the operator's manual. Some switches on the dash may require that the vehicle either be at a specific speed, have park brakes set, or another device to be ON or OFF for the air device to operate. The Instrument Cluster will show information regarding what needs to change in order for the air device to operate as expected. The following table provides a list of icons that are additional for EVs that may be found on the switch.

Symbol	Indicator	Color
 LVD	<i>Batteries, 12 V Disconnect</i> on page 42	None
	<i>Stop Charging</i> on page 42	Green

Batteries, 12 V Disconnect



This Low Voltage Disconnect (LVD) dash switch is used to disable the LVD, which prevents the low voltage disconnect system from shutting power off.

Stop Charging



The Stop Charging switch allows the operator to stop the charging. This switch illuminates green when the charge plug is connected to the vehicle's charge inlet port and the charge plug is unlocked. See [Stop Charging Switch](#) on page 49 for more specifications of this switch.

Right-Hand Stalk

Right-hand stalk shifter controls both the Drive Mode and the Regenerative Braking System.

Regenerative Braking System (RBS)

Move the stalk clockwise about the steering column axis to select the regenerative braking level. Refer to [Regenerative Braking System](#) on page 31 to see more information about the RBS operation.

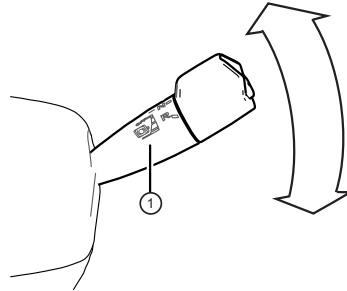

1. Regenerative Braking System

Drive Mode Selector

Turn the stalk end clockwise about the stalk axis to select the modes D-N-R.

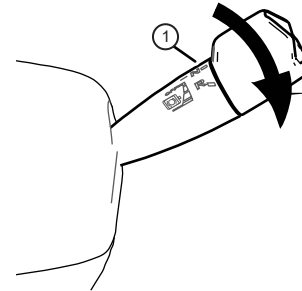

1. Drive Mode Selector

Chapter 4 | E-POWERTRAIN OPERATIONS

Initiating a Charge.....	45
Disconnecting the Charger.....	49
Starting Up.....	49
Charging Settings.....	50

Initiating a Charge



WARNING

DO NOT connect the charging plug into the vehicle charge inlet without first setting the parking brake. If the vehicle is not secured to prevent uncontrolled movement, it could roll away. Failure to comply may result in death, personal injury, equipment damage, or property damage.



CAUTION

Although the temperature of the batteries are adjusted automatically, always attempt to maintain the vehicle away from high or low ambient temperatures while charging to mitigate weather related range loss. Failure to comply may result in reduced battery durability.

1. Stop the vehicle.

2. Set the Vehicle Mode to Neutral.
3. Engage the park brake.



WARNING

Ensure the charging cable and charger plug are dry and free from any damage. Failure to comply may result in death, personal injury, equipment damage, or property damage.

4. Leave the 12 V disconnect switch in the ON position.
5. Plug in the charger plug.

Charge Inlet Components

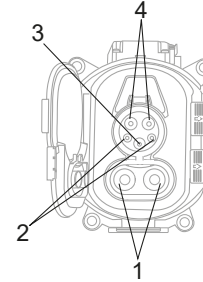

1. DC charger receptacle
 2. Signal ports
 3. Ground port
 4. AC charger receptacle
6. Wait until the charge port LED shows the DC or AC charging status.

 **NOTE**

There may be a short delay between when the charger is plugged in and when the vehicle starts charging. If charging does not commence after the short delay, restart the sequence by first unplugging the charger then turning off the 12 V disconnect switch ⁵. Always make sure the 12 V disconnect switch is ON before attempting again.

 **NOTE**

The prescheduling feature can be used to set a desired percentage for the battery to stop charging. Refer to [Prescheduling](#) on page 50.

 **NOTE**

Battery balancing happens continuously during charging and discharging the vehicle. For the durability of the battery system, PACCAR recommends

to fully charge or discharge the vehicle. See [Battery Balancing](#) on page 17.

 **CAUTION**

NEVER place the 12 V disconnect switch in the OFF position while charging or running the vehicle. Removing the low voltage power while charging or running will damage the high-voltage power electronics. Failure to comply may result in equipment or property damage.

 **CAUTION**

DO NOT attempt to enter Drive or Reverse while the vehicle is charging. The D or the R indicator will turn amber and the Move Disallowed status indicator along with the "Unplug Charger" message will be displayed on the Digital Display. The charge plug must be unplugged before the vehicle can

be driven. Failure to comply may result in equipment or property damage.

 **CAUTION**

Ensure the charger plug is correctly connected. A loose connection will cause excessive heat and may damage the charger. Failure to comply may result in equipment or property damage.

Charging Considerations

For maximum performance and durability of batteries, ensure to fully charge or discharge the vehicle to enable State of Charge (SOC) calibration. See [Battery Balancing](#) on page 17.

You can observe the State of Charge (SOC) on the gauge that is located on the upper left side of the Digital Display.

 8%

When the SOC gets to a low charge status, a series of non-suppressible telltales on the display and audible warnings are triggered and results in a progressive loss

⁵ The 12 V disconnect switch can only be turned OFF when restarting the sequence.

of functionality. If the SOC gets to a critical status, power consumption systems of low priority will be disabled, like the cab A/C and the PTO, and the Move Disallowed telltale appears, indicating the vehicle's shutdown. See [Battery Gauge and Estimated Range](#) on page 16 for more detailed information.

	NOTE
<p>Battery balancing happens continuously during charging and discharging the vehicle. PACCAR recommends to fully charge or discharge the vehicle. See Battery Balancing on page 17.</p>	

	WARNING
<p>DO NOT open the high-voltage battery enclosure for any reason. The battery packs are part of the high-voltage system and do not contain operator-serviceable items. Please contact or take the vehicle to an authorized EV service certified dealership for service. Failure to comply may result in death, personal injury, equipment damage, or property damage.</p>	

	WARNING
<p>DO NOT attempt to diagnose or correct any vehicle issues related to the high-voltage electrical system or components. Please contact or take the vehicle to an authorized EV service</p>	

<p>certified dealership for service. Attempting to diagnose or correct vehicle issues may result in death, personal injury, equipment damage or property damage.</p>
--

Charging Status

The following information may be present on the Charge Port LED and the Digital Display depending on vehicle status charging:

Charge Port LED Status

LED Color	Charging Status
Flashing green	DC fast charging
Solid green	Charging complete
Flashing green and then flashing yellow	AC charging (no errors)

LED Color	Charging Status
Flashing red and then flashing yellow	DC or AC charge rate severely limited
Flashing red	Charging error





Charging Digital Display Status

When charging the vehicle, the Digital Display will show the charging status with

the indicator shown in the table below. The indicator changes color and displays

alongside a message depending on the charging status.

4

Charging Indicator on Top Bar	Color	Message
	Blue	Charging Complete
	Amber	Charger Fault
	Amber	Vehicle Charging Fault
	Amber	Set Park Brake to Charge
	Green	Battery is Charging
	Blue	Initializing Charging

Control Plug-in Charge

The control plug-in charge is a function that enables the vehicle to receive electrical energy from electrical mains/grid. This energy may be applied to the charging of the electric vehicle's high-voltage battery and/or providing power to e-auxiliaries.

Stop Charging Switch

The Stop Charging switch illuminates green when the charge plug is connected to the vehicle's charge inlet port and the charge plug is unlocked.

While charging is occurring, the plug will be locked so this switch will not be illuminated. Pressing the switch while actively charging will send a signal to cancel the current charge and unlock the plug. To disconnect the charge cable, charging must be stopped. This can be done via the charger's interface.

If the Plug Security feature is set to **ON** in the **Menu > Settings > Charging > Plug Security**, this button must be pressed in order to unlock the plug when charging has completed.

Disconnecting the Charger



WARNING

DO NOT connect the charging plug into the vehicle charge inlet without first setting the parking brake. If the vehicle is not secured to prevent uncontrolled movement, it could roll away. Failure to comply may result in death, personal injury, equipment damage, or property damage.



CAUTION

DO NOT attempt to enter Drive or Reverse while the vehicle is charging. The D or the R indicator will turn amber and the Move Disallowed status indicator along with the "Unplug Charger" message will be displayed on the Digital Display. The charge plug must be unplugged before the vehicle can be driven. Failure to comply may result in equipment or property damage.

1. Wait for the battery to achieve the 100% SOC or the target SOC (if activated in the menu), which will illuminate the charge port solid green.



NOTE

If you need to disconnect the charger before it automatically completes charging, press the stop charging switch to end the charge.

2. Disconnect the charger plug.

Starting Up



WARNING

Only visually inspect high-voltage components. Failure to comply with this warning could result in injury or death if high voltage components are loose or damaged.



WARNING

If cables or components are damaged DO NOT attempt to repair the vehicle on your own, as you could receive an electric shock. Please contact or take the vehicle to an authorized EV service certified dealership for service. Failure to comply may result in death, personal injury, equipment damage, or property damage.

1. Remove the charger plug if connected.
2. Turn ON the 12 V Disconnect switch, if necessary.



CAUTION

The 12 V Disconnect switch must remain ON while the vehicle is charging or running. If the 12 V Disconnect switch is OFF, this will cause damage to the batteries resulting in batteries' durability derate. Failure to comply may result in equipment or property damage.

3. Turn the start switch clockwise to the ON position.
4. Release the park brake.
5. Depress the service brake.
6. Put the vehicle in Drive (D) or Reverse (R).
7. The vehicle will be ready to move when the Ready to Move indicator illuminates green. See [Ready to Move](#) on page 40.



WARNING

Pull over if a warning light is present. Attempting to drive the vehicle could permanently damage the batteries or the vehicle's components. Failure to comply may result in death, personal injury, equipment damage, or property damage.



WARNING

Vehicle noise may be reduced in some operation modes. The vehicle operator must remain aware of nearby vehicles or pedestrians at all times. Failure to comply may result in death, personal

injury, equipment damage, or property damage.

Vehicle Warm-Up

Vehicle warm-up allows the vehicle to warm-up the batteries and cabin using the energy storage from the vehicle or using the charger to be in optimal conditions before driving. The vehicle can automatically be warmed-up by choosing a Planned Departure time in the Settings menu. See [Planned Departure](#) on page 53.



NOTE

PACCAR recommends to use the Pre-conditioning feature to properly warm-up or precondition the vehicle.

Charging Settings

Prescheduling

The Prescheduling feature allows the operator to specify the charging settings:

- Scheduled Charging: the time to start charging
- Charge Target: the target SOC

- Planned Departure: the pre-conditions of the batteries and cab before a drive

These settings can only be set on the charging sub-menu and will be displayed on the charging overview screen.

Vehicle Charging with Scheduled Charging and Charge Target Active

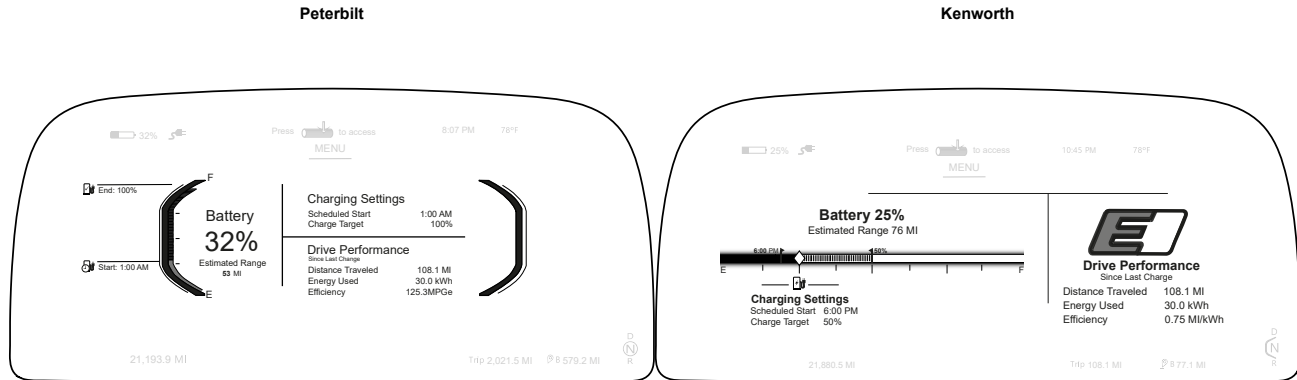

Scheduled Charging

The Scheduled Charging is off by default and is a feature that allows the operator to set a time when the vehicle will start charging. When active, this feature will attempt to charge the vehicle daily at the

preselected time. The scheduled charging is independent of Charge Target and Planned Departure features. Perform the following procedures to activate this feature and set a scheduled charging:

1. Open the Main Menu.

2. Select **Charging** in the Main Menu.

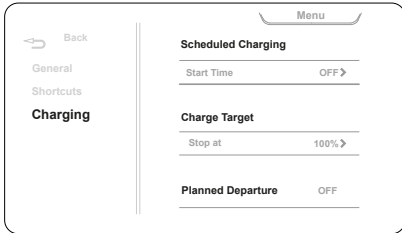

3. Select **Start Time** located in the **Scheduled Charging** option.
4. Use the steering wheel switches to set to the **ON** position and select the desired time for the batteries to start charging.

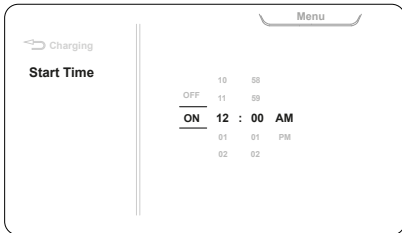

The vehicle can remain plugged in, but the charging will not start until the set time is reached; when this feature is set to OFF, the charging starts immediately

5. Finally, go back to the Main Menu and exit.

Charge Target

The Charge Target is a feature that allows the operator to select a desired State of Charge (SOC) level at which the vehicle will stop charging. Perform the following procedure to set a charge target:

1. Open the Main Menu.
2. Select **Charging** in the Main Menu.

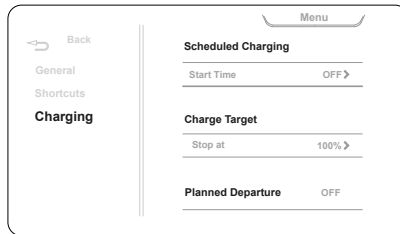

3. Select **Stop at** located in the **Charge Target** option.

4. Use the steering wheel controls to select a desired SOC level at which the vehicle will stop charging.

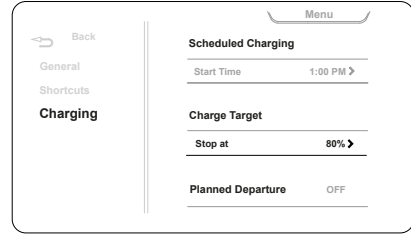

NOTE

This function may not be available if the batteries have not been fully charged for several cycles.

**NOTE**

The vehicle must be charged to 100% periodically to maintain State of Charge (SOC) calibration. The vehicle will automatically attempt to charge to 100% at certain intervals, even if a stop charging target is set.

**NOTE**

Once the set level is reached, the level of the charge target resets to 100%.

**WARNING**

Charging the vehicle to 98% or higher disables regenerative braking until the State of Charge (SOC) is below 98%. **In situations where regenerative braking is disabled, rely on the service brakes to slow or stop the vehicle.** Failure to comply may result in death, personal injury, equipment damage, or property damage.

- Finally, go back to the Main Menu and exit.

Planned Departure

The Planned Departure (Preconditioning) feature allows the operator to set a

departure time for which the vehicle will automatically regulate the temperature of the batteries and the cab as per the operator settings. The operator can activate this feature in the **Charging** sub-menu to set the day of the week and time to precondition the vehicle departure. The departure day and time information is displayed on the **Charging** overview screen.

**NOTE**

Preconditioning can be done using the energy from the vehicle or the charger cable plugged in.

Vehicle Charging with Planned Departure Active

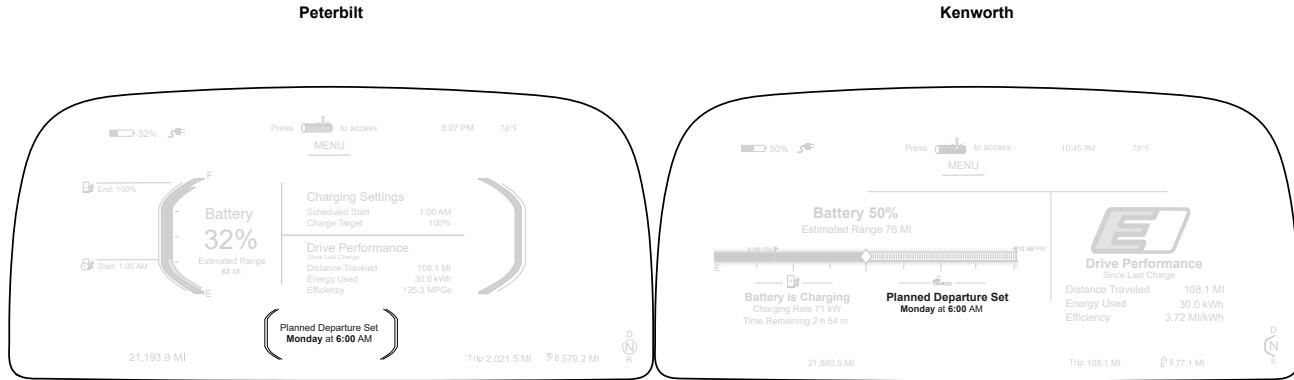

1. Open the Main Menu.
2. Select **Charging** located in the Main Menu.

Setting Planned Departure

The Planned Departure feature allows the operator to schedule a planned departure for the vehicle each day of the week, this will allow the system to precondition the vehicle before operation. Planned Departure is off by default. Perform the following procedure to activate this feature and set a planned departure:

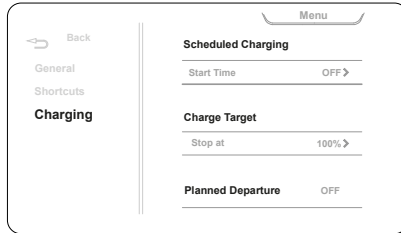

3. Select **Planned Departure**.

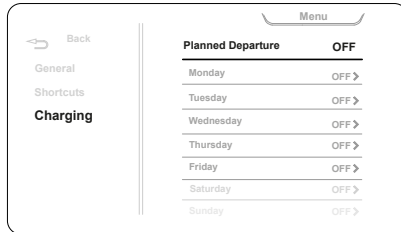

4. Set to the **ON** position and select the planned time for each day by setting the planned time of departure.

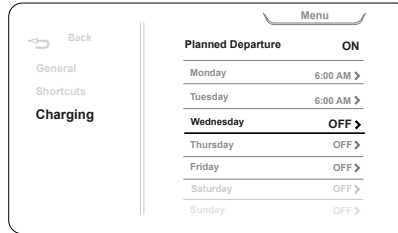

5. Finally, go back to the Main Menu and exit.

NOTE

The Charging Menu has an ON/OFF option for Plug Security when charging in public places. If set to ON, this requires the Stop Charging switch to be pressed to release the charging cable from the vehicle.

Chapter 5 | MAINTENANCE

Preventive Maintenance.....	57
Preventive Maintenance Schedule.....	58
Daily Inspections.....	60
PCAS Maintenance.....	61
Checking Power Steering Fluid Level.....	68
Draining Power Steering Fluid.....	70
Low Voltage Batteries.....	71
High-Voltage Batteries.....	75
Single Point Disconnect Switch.....	77
Service Locations.....	78

Preventive Maintenance

Preventive maintenance begins with the daily checks listed in your vehicle's operator's manual. Routine vehicle checks can help avoid many large, expensive, and time-consuming repairs. Neglecting recommended maintenance can void your vehicle's warranty. Maintenance operations on the e-powertrain system, such as inspections, are the only tasks that must be performed by the operator; the rest of the maintenance operations demand skills and equipment that only an EV service certified dealership can perform. Please contact or take your vehicle to an EV service certified dealership. See [Service Locations](#) on page 78.

 **WARNING**

DO NOT attempt to service this vehicle. Only an EV service certified dealership is authorized to service a PAC-CAR electric vehicle (EV). EVs use high voltage, posing additional hazards not present when servicing a conventional vehicle. Servicing high voltage components requires proper train-

ing, tools, and equipment. **Visual inspections are the only tasks that should be performed by the operator.** Failure to comply may result in death, personal injury, equipment damage, or property damage.

 **WARNING**

DO NOT touch or attempt to remove any of the orange high voltage (HV) cables, connectors, or components for any reason. **If asked to inspect HV component or cabling, only inspect visually.** Failure to comply may result in death or personal injury.

 **WARNING**

If any issues involving the high-voltage electrical system are discovered, DO NOT drive the vehicle. Please contact or take the vehicle to an authorized EV service certified dealership for service. Failure to comply may result in death, personal injury, equipment damage, or property damage.

 **WARNING**

DO NOT attempt maintenance or repair work on the e-powertrain system. The only tasks that can be performed by an operator on this system are visual inspections. Only an EV service certified dealership is authorized to service the vehicle. Failure to comply may result in death, personal injury, equipment damage, or property damage.

 **WARNING**

Ensure any modifications to the vehicle DO NOT affect the high-voltage system. A modification could affect the high voltage electrical system, resulting in electric shock, burns or even death, and will void the warranty. Failure to comply may result in death, personal injury, equipment damage, or property damage.



WARNING

DO NOT attempt to diagnose or correct any vehicle issues related to the high-voltage electrical system or com-

ponents. Please contact or take the vehicle to an authorized EV service certified dealership for service. Attempting to diagnose or correct vehicle issues may result in death, personal

injury, equipment damage or property damage.

Preventive Maintenance Schedule

E-Fan (High Voltage)

Every 10,000 mi / 16,000 km

E-Fan - High Voltage

- Inspect the fans for cracks or chips in the blades potentially caused by impact from rocks or debris.^{6*}

E-Motor (High Voltage)

Every 75,000 mi / 120,000 km / Every 2 Years (Vocational, Refuse, Pickup/Delivery)

Oil - E-Motor

- Drain and replace the oil.⁷ See [E-Motor Oil Specifications](#) on page 81 for specific oil.
- Replace the oil filter.

⁶ Inspect but DO NOT touch the e-fan and any other part of the high voltage system.

^{*} The operator must perform this inspection according to this interval or when any issue with the fan or airflow is encountered.

⁷ The specifications in this section are for informational purposes, DO NOT attempt to perform any service. Service tasks must be performed and de-energized ONLY by an EV service certified dealership with the proper Personal Protective Equipment (PPE) and facilities.

Every 2 years

Cooling - E-Motor

- Drain and replace the coolant.⁸ See [E-Motor Coolant Specifications](#) on page 81 for specific coolant.^{9*}

High-Voltage Batteries

Every year

State of Health (SOH) - Batteries

- Calibrate the State of Health (SOH). See [HV State of Health \(SOH\) Calibration](#) on page 75.

Every 2 years

Battery Coolant System - Batteries

- Inspect the manifolds and coolant routings to prevent leaks.

Air Compressor

⁸ The specifications in this section are for informational purposes, do not attempt to perform any service. Service tasks must be performed and de-energized ONLY by an EV service certified dealership with the proper Personal Protective Equipment (PPE) and facilities.

⁹ Maintenance or repair works must be performed by an EV service certified dealership. If any questions arise, contact an authorized EV service certified dealership.

* Coolant must be changed every 2 years, irrespective of mileage.

Every year / 1,500 hours

Oil - Air Compressor

- Drain and replace the oil. Refer to [Refilling Air Compressor Oil](#) on page 63.
- Replace the coalescing filter. Refer to [Coalescing Filter Replacement](#) on page 65.
- Replace the air filter. Refer to [Air Filter Cartridge Replacement](#) on page 67.
- Visually inspect for damage or leaks.

Daily Inspections

Required tools:

- None



WARNING

DO NOT attempt to service this vehicle. Only an EV service certified dealership is authorized to service a PAC-CAR electric vehicle (EV). EVs use high voltage, posing additional hazards not present when servicing a conventional vehicle. Servicing high voltage components requires proper training, tools, and equipment. **Visual inspections are the only tasks that should be performed by the operator.** Failure to comply may result in

death, personal injury, equipment damage, or property damage.

The following daily inspections must be performed by the operator.

- **Batteries**
 1. Visually inspect high-voltage cables (orange cables) are connected and properly secured.
 2. Ensure there are no fluids leaking from the battery enclosures.
 3. Ensure the State of Charge (SOC) is not too low. See [Charging Considerations](#) on page 46.
- **E-Motor**
 1. Ensure there are no leaks from the e-motor below the vehicle.



WARNING

If cables or components are damaged DO NOT attempt to repair the vehicle on your own, as you could receive an electric shock. Please contact or take the vehicle to an authorized EV service certified dealership for service. Failure to comply may result in death, personal injury, equipment damage, or property damage.

 **WARNING**

DO NOT touch any part of the high-voltage electrical system or its components. They are high voltage and you could receive an electric shock. Failure to comply may result in death, personal injury, equipment damage, or property damage.

injury, equipment damage or property damage.

may result in death, personal injury, equipment damage, or property damage.

PCAS Maintenance

Required tools:

- None

 **WARNING**

DO NOT attempt to diagnose or correct any vehicle issues related to the high-voltage electrical system or components. Please contact or take the vehicle to an authorized EV service certified dealership for service. Attempting to diagnose or correct vehicle issues may result in death, personal

 **WARNING**

If any issues involving the high-voltage electrical system are discovered, DO NOT drive the vehicle. Please contact or take the vehicle to an authorized EV service certified dealership for service. Failure to comply may result in death, personal injury, equipment damage, or property damage.

1. Safely shut down the vehicle.
2. Obtain access to the PCAS. Typically, the PCAS is located where the conventional engine would be. Finding it may require opening the hood or tilting the cab.

 **WARNING**

Always ensure the hood lock has engaged whenever the hood is opened. Failure to lock the hood open may result in the hood closing uncontrollably, which may result in death, personal injury, equipment damage, or property damage.

 **WARNING**

Always open the hood with both feet planted firmly on the ground and one or both hands on the hood. If you lose your footing, the hood may open or close uncontrollably. Failure to comply

3. Inspect the e-powertrain, suspension, electrical system, and vehicle components for broken connections, dangling wires/cables, wear, and leaks on components.
4. Check if any liquid is visible on the ground under the vehicle. Contact service assistance if fluid is found under the vehicle.
5. Check the coolant level in the accessory coolant and the Energy Storage System (ESS) coolant reservoirs and add coolant if needed. Recommended coolant TRP Extended Life Coolant (ELC) Prediluted 50/50.

6. Verify that the air compressor lines, fittings, and connections are all secure, intact, and unbroken.
7. Verify that all the electrical cables and connections are secured in place, undamaged, and un-chafed. Check if any high-voltage cables are loose or hanging down where they can be hit by road debris.
8. Locate the charge port unit on the vehicle. Inspect the charge port for dirt and debris and clean with a dry, lint-free cloth if necessary.

9. Locate the ESS battery assemblies. Verify there are no signs of damage and remove any debris or foreign objects that may have been collected near the battery enclosures and mounting brackets.
10. Locate the HV cables connected to the powertrain. Inspect for loose, hanging, or broken connections on cables, wires, and parts.

Refer to [PCAS Maintenance Schedule](#) on page 62 to see the maintenance schedule the operator must follow to ensure the safe and efficient function of the PCAS.

PCAS Maintenance Schedule

	NOTE
Preventive Maintenance must be performed as scheduled by an EV service certified dealership.	

Every 3 Months
Hydraulic fluid <ul style="list-style-type: none"> • Check hydraulic fluid level. Refer to Checking Power Steering Fluid Level on page 68
HV warning labels <ul style="list-style-type: none"> • Verify that the labels are legible. Replace with new labels as necessary. Refer to Battery Electric Vehicle (BEV) Safety Labels on page 6

Every Year

Hydraulic Fluid

- Drain and replace hydraulic fluid. Refer to [Draining Power Steering Fluid](#) on page 70

Every 1500 hrs / Annually

Air compressor filter and fluid

- Service per [Refilling Air Compressor Oil](#) on page 63 specifications.

Every 120,000 mi / 192,000 km / Annually

Electronics cooling system

- Use a galvanometer or refractometer to check the cooling system coolant level and strength (-7°C/-35°F).

Power Steering - (on Highway)

- Drain, replace the filter, and refill. Refer to [Checking Power Steering Fluid Level](#) on page 68 for maintenance instructions.

Air Compressor Maintenance

Refilling Air Compressor Oil

Required tools:

- 8 mm allen wrench
- Adjustable wrench

	CAUTION
Stop the vehicle at an horizontal position and ensure all suspension airbags or bellow are equally filled to level the	

vehicle before topping up the oil. If the airbags are not filled, it can cause the vehicle's nose tilting up. Failure to comply may result in equipment or property damage.

The vehicle displays an oil warning when the air compressor oil level is low or needs

to be changed. Perform a complete drainage of the oil prior to refilling procedure. Refer to *Cleaning Vacuum Oil Drainage* on page 64 for more specifications.

Check and refill the oil/fluid on the air compressor following these steps:

1. Park the vehicle on level ground and turn off the vehicle.
2. Switch off the start switch and prevent it from restarting by disconnecting the 12 V Disconnect switch.
3. Open the hood.



WARNING

Always ensure the hood lock has engaged whenever the hood is opened. Failure to lock the hood open may result in the hood closing uncontrollably, which may result in death, personal injury, equipment damage, or property damage.



WARNING

Always open the hood with both feet planted firmly on the ground and one

or both hands on the hood. If you lose your footing, the hood may open or close uncontrollably. Failure to comply may result in death, personal injury, equipment damage, or property damage.

4. Release the trapped pressure in the compressor as follows:
 - a. Loosen the nut of the filling plug C partially for one turn.
 - b. Wait until the pressure is entirely released.
 - c. Loosen the nut of the filling plug C completely.
5. Unscrew the filling plug A and refill the oil/fluid as follows:

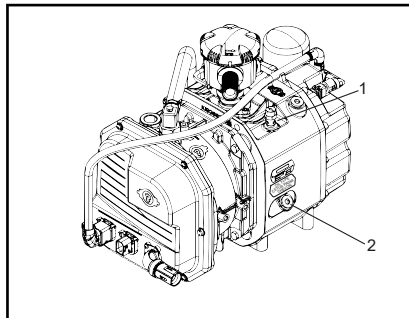

1. Filling plug C
2. Filling plug A

- a. Top up the oil until it reaches the bottom of the thread at plug A port (oil quantity needed is 1.9 L approx.).
- b. Top up the oil until it reaches 161mm from the top plug surface.
6. Screw a new sealing washer to tightening torque 20 to 24 ft-lb (27 to 33 N·m) in the top filling plugs A and C.

Cleaning Vacuum Oil Drainage

Required tools:

- Screwdriver
- Tube of 12 mm external diameter and 300 mm length approx.
- Oil extractor
- Container or oil pan

Clean the oil drainage on the air compressor following these steps:

1. Unscrew the top drainage plug C.

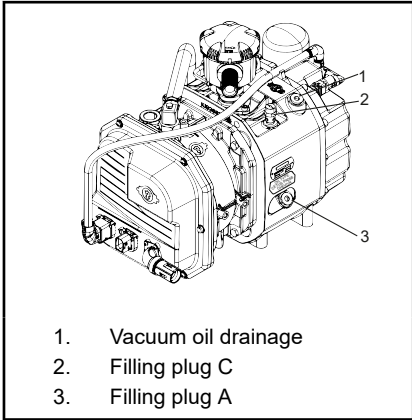

1. Vacuum oil drainage
2. Filling plug C
3. Filling plug A

2. Use a tube with an external diameter of 12 mm and length of 300 mm approx.
3. Insert the tube inside the compressor and suck out the oil.
4. Dispose of the oil in accordance with national/local regulations.
5. Screw a new sealing washer to tightening torque 20 to 24 ft-lb (27 to 33 N·m) in the top drainage plug C.

6. Fill the reservoir to a proper level with an approved oil for the compressor.

Coalescing Filter Replacement

Special tools:

- Adjustable strap wrench
- Panel clip remover

CAUTION

Stop the vehicle at an horizontal position and ensure all suspension airbags or bellow are equally filled to level the vehicle before topping up the oil. If the airbags are not filled, it can cause the vehicle's nose tilting up. Failure to comply may result in equipment or property damage.

Procedure to replace the coalescing filter is shown below:

1. Park the vehicle on level ground and turn off the vehicle.
2. Switch off the Start switch and prevent it from restarting by disconnecting the 12 V Disconnect switch.
3. Open the hood.

WARNING

Always ensure the hood lock has engaged whenever the hood is opened. Failure to lock the hood open may result in the hood closing uncontrollably, which may result in death, personal injury, equipment damage, or property damage.

WARNING

Always open the hood with both feet planted firmly on the ground and one or both hands on the hood. If you lose your footing, the hood may open or close uncontrollably. Failure to comply may result in death, personal injury, equipment damage, or property damage.

4. Vent the pneumatic system entirely as follows:

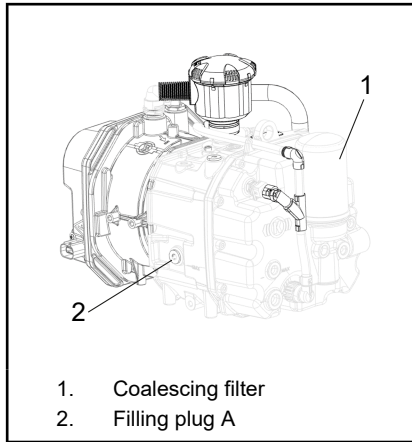

- a. Unscrew the filling plug A for one turn.
 - b. Wait until the pressure is entirely released.
 - c. Unscrew the filling plug A completely.
5. Unscrew coalescing filter using a strap wrench.

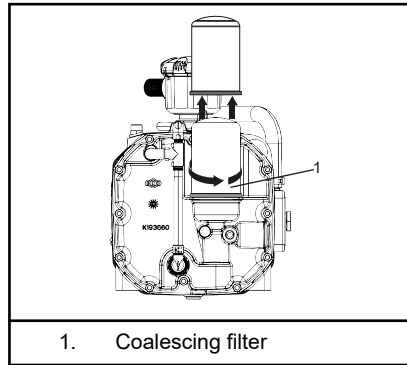

6. Remove the plastic clip of the thermal insulation upper part using a panel clip remover and remove the upper part of the thermal insulation.

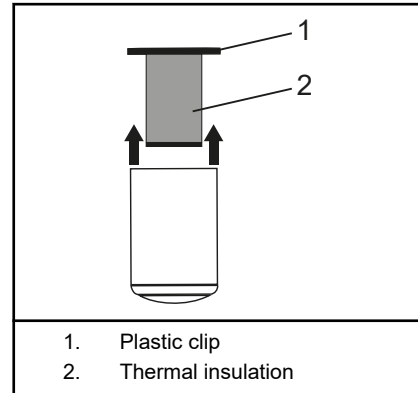

7. Lubricate the sealing surface of the new oil trap with a thin film of the specified compressor oil. Then install the new oil trap and screw in tight by hand (1/4 turn after gasket contact). Observe the assembly instructions printed on the oil trap.
8. Put back the insulation upper part.
9. Put back the clip to maintain the insulation upper part closed and tightened.
10. Clearly hear the “clicks” from the clip ensuring it is well tightened.
11. Top up the oil.

12. Screw a new sealing washer to tightening torque 20 to 24 ft-lb (27 to 33 N·m) in the filling plug A.

Air Filter Cartridge Replacement

Required tools:

- Manual screwdriver
- Clean rag

Procedure to replace the air filter cartridge is shown below:

1. Park the vehicle on level ground and turn off the vehicle.
2. Switch off the start switch and prevent it from restarting by disconnecting the 12 V Disconnect switch.
3. Open the hood.



WARNING

Always ensure the hood lock has engaged whenever the hood is opened. Failure to lock the hood open may result in the hood closing uncontrollably, which may result in death, personal injury, equipment damage, or property damage.



WARNING

Always open the hood with both feet planted firmly on the ground and one or both hands on the hood. If you lose your footing, the hood may open or close uncontrollably. Failure to comply may result in death, personal injury, equipment damage, or property damage.

4. Unscrew the air filter plastic cover (bayonet).
5. Remove the old air filter cartridge.
6. Clean the air filter housing with a rag to remove oil, particles, wetness, etc.
7. Install the new air filter cartridge.
8. Screw the air filter plastic cover (bayonet).

Air Filter Housing Replacement

Required tools:

- Screwdriver
- Clean rag

Procedure to replace the air filter housing is shown below

1. Park the vehicle on level ground and turn off the vehicle.

2. Switch off the start switch and prevent it from restarting by disconnecting the 12 V Disconnect switch.
3. Open the hood.



WARNING

Always ensure the hood lock has engaged whenever the hood is opened. Failure to lock the hood open may result in the hood closing uncontrollably, which may result in death, personal injury, equipment damage, or property damage.



WARNING

Always open the hood with both feet planted firmly on the ground and one or both hands on the hood. If you lose your footing, the hood may open or close uncontrollably. Failure to comply may result in death, personal injury, equipment damage, or property damage.

4. Unscrew clamping band.
5. Remove old air filter, clamping band, and rubber ring.

6. Clean the inlet pipe contour with a rag to remove oil, particles, wetness, etc.
7. Install the new rubber ring on the air inlet pipe.
8. Install the new air filter and clamping band on the rubber ring.
9. Torque the clamping band with a manual screwdriver only to 1.4 ft-lb (2 N·m).

Checking Power Steering Fluid Level



WARNING

Hydraulic fluids and hydraulic brake fluids are toxic substances. DO NOT allow hydraulic fluids to get into your mouth or onto your skin. Wear impervious protective clothing and gloves when handling hydraulic fluids. In the event of slight skin contact, thoroughly rinse the affected area with clean water. If there is excessive skin contact or any ingestion/inhalation, seek medical advice immediately. Failure to comply

may result in death, personal injury, equipment damage, or property damage.



CAUTION

The presence of dirty or foreign particles in the fluid reservoir or power steering system can cause severe damage to the components. Clean the area before opening any part of the power steering system. Failure to comply may result in equipment or property damage.



CAUTION

When adding fluid, only use fluid of the same type. While many fluids have the same description and intended purpose, they may contain incompatible additives. Incompatible fluids may cause damage to power steering system components. Failure to comply may result in equipment or property damage.



NOTE

Before removing reservoir cap, wipe the outside of the cap so that no dirt or debris falls into the reservoir.

Check the fluid level. Use the following procedure:

1. Park the vehicle on level ground and turn off the vehicle.
2. Open the hood.



WARNING

Always open the hood with both feet planted firmly on the ground and one or both hands on the hood. If you lose your footing, the hood may open or close uncontrollably. Failure to comply may result in death, personal injury, equipment damage, or property damage.



WARNING

Always ensure the hood lock has engaged whenever the hood is opened. Failure to lock the hood open may result in the hood closing uncontrollably, which may result in death, personal injury, equipment damage, or property damage.

3. Check the fluid level on the reservoir.

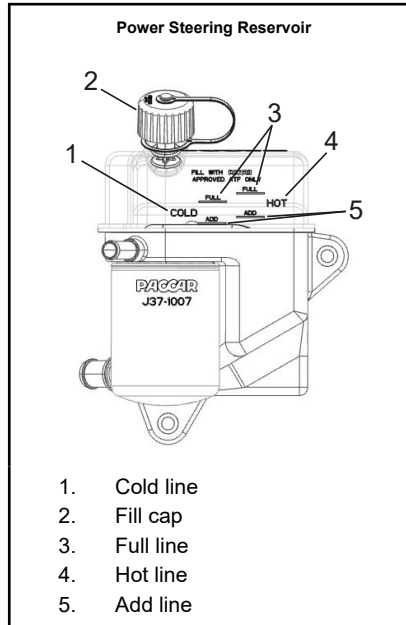

- If you check the fluid with the PCAS and steering system cold, the fluid level should be above the COLD ADD indicator

level and should generally not exceed the middle point between the COLD ADD and COLD FULL level indicators.

- If you check the fluid with the steering system warm, the fluid should not exceed the HOT FULL level indicator and should generally not drop below the middle point between the HOT FULL and HOT ADD level indicators.
4. To add fluid, open the fill cap to the power steering reservoir and then add fluid until the fluid level is in the middle of the appropriate minimum and maximum level indicators.
 5. Reinstall the reservoir fill cap and close the hood.

5



WARNING

Before closing the hood, ensure no objects are in the way. Close the hood in a controlled manner and DO NOT let go with hands firmly grasping the hood and feet on a stable, non-slip surface. Failure to comply may result in death, personal injury, equipment damage, or property damage.

Draining Power Steering Fluid

Required tools:

- Steering fluid: DEXRON 3 or DEXRON 6
- Jack
- Jack stands
- Suction device
- Container

Drain the power steering fluid. Perform the following procedure:

1. Park the vehicle on a level surface and turn the engine OFF.
2. Block the rear wheels to prevent the vehicle from moving.
3. Set the parking brake. Place the transmission in neutral.



CAUTION

DO NOT turn the steering wheel when draining the power steering fluid. Otherwise, air may be induced into the system. Failure to comply may result in equipment or property damage.

4. Open the hood and locate the power steering reservoir.



WARNING

Always ensure the hood lock has engaged whenever the hood is opened. Failure to lock the hood open may result in the hood closing uncontrollably, which may result in death, personal injury, equipment damage, or property damage.



WARNING

Always open the hood with both feet planted firmly on the ground and one or both hands on the hood. If you lose your footing, the hood may open or close uncontrollably. Failure to comply may result in death, personal injury, equipment damage, or property damage.

5. Remove the cap and leave it hanging by its tether.
6. Using a suitable suction device, remove the power steering fluid from the reservoir.

7. Position a container below the reservoir and disconnect the hoses.
8. Drain the fluid from the reservoir into the container.
9. Refill the reservoir nearly full with new fluid. Set the switch to the ON position for 10 seconds. Check fluid level and refill if necessary. Repeat at least three times, each time checking and refilling the reservoir if needed. Repeat until the fluid level does not drop.
10. Start the vehicle for two minutes while continuously monitoring the fluid level. Turn off the engine and fill reservoir as necessary.
11. Fill the system up to the cold mark with fluid until it reaches the maximum level indicator.
12. With the key OFF, steer the vehicle from full left to full right several times, only lightly contacting the steering stops. Add fluid, as necessary, to the maximum level indicator.



CAUTION

If equipped with a manual bleed screw, do not turn steering wheel with bleed screw loosened as it could introduce air into the system. Failure to comply may result in equipment or property damage.



CAUTION

Do not hold the steering wheel against the stops for more than five seconds. Failure to comply will cause damage to the power steering pump that may not be immediately apparent. Failure to comply may result in equipment or property damage.

13. Start the vehicle and cycle the steering wheel fully from stop-to-stop three times.
14. Stop the vehicle. Check the fluid level and fill as needed.
15. Start the key ON.
16. Cycle the steering wheel fully from stop-to-stop ten times.
17. Stop the vehicle.

18. Check the fluid level and fill as needed.
19. Visually inspect the power steering system for leaks.
20. Close the hood.



WARNING

Before closing the hood, ensure no objects are in the way. Close the hood in a controlled manner and DO NOT let go with hands firmly grasping the hood and feet on a stable, non-slip surface. Failure to comply may result in death, personal injury, equipment damage, or property damage.

Low Voltage Batteries

Regular attention to the charging system will help prolong the service life of the batteries.



WARNING

Batteries contain acid that can burn and gases that can explode. Ignoring safety procedures may result in death,

personal injury, equipment or property damage.



WARNING

Never remove or tamper with battery caps. Ignoring this could allow battery acid to contact eyes, skin, fabrics, or painted surfaces. Failure to comply may result in property damage, personal injury, or death.



CAUTION

DO NOT store other items in the battery box. Failure to comply could result in damage to the vehicle and/or batteries.



CAUTION

Properly secure battery tie downs and battery box cover when reinstalling batteries after service. DO NOT over tighten. Over tightening can crack the battery case which can lead to equipment damage.

Some common causes of battery failure are:

- Overcharge: this condition results from improper voltage regulator adjustment. It results in overheating of the battery, warped plates, and evaporation of electrolyte.
- Undercharge: if your vehicle has undergone long periods of inactivity or short distance driving. These conditions result in battery plates becoming covered with a hard coating.
- Vibration: loose battery hold-downs may cause battery plate failure.
- Short circuits: these discharge the battery by draining electricity.
- Dirty or loose connections: improper connections may stop the

flow of electrical power to and from the battery.

Low Voltage Battery Charging



WARNING

Batteries can injure you severely. They contain acid, produce poisonous and explosive gases, and supply levels of electric current high enough to cause burns. A spark or flame near a battery on charge may cause it to explode with great force. Never remove or tamper with the battery caps. Failure to comply may result in death, personal injury, equipment damage or property damage.

The recommended maximum current for the low voltage batteries are the following:

- Odyssey PC2150 AGM – 100A per battery
- East Penn AGM – 33A per battery

Only trickle charge the batteries to maintain battery condition. Have the batteries fully deep-charged by a qualified service facility. To help reduce the risk of personal injuries, follow these guidelines carefully when recharging a battery:

- Before attempting any service in the electrical installation, disconnect the battery negative cable.
- Allow no sparks or open flame anywhere near the charging area.
- Trickle charge a battery only in a well-ventilated area such as outdoors or in a fully open garage. No open flames, including pilot lights can be present. Allow explosive gases generated during the charging process to escape.
- Always make sure that the battery charger is OFF before connecting or disconnecting the cable clamps.
- Never store or rest metal tools like jumper cables close to the battery. Metal must not come in contact with the positive battery terminal while also touching any other metal on the vehicle. The vehicle's body and frame are the electrical systems ground. Accidentally connecting the positive terminal directly to the frame or body could cause a short circuit and possibly an explosion.

Low-Voltage Battery Charging Reminders

- Use protective eyewear.
- Keep all batteries away from children.
- Never reverse battery poles.
- Never attempt to place the vehicle in motion with batteries disconnected.
- Keep the battery clean and dry.
- Look for any signs of damage.
- Battery terminals should not be coated with improper grease. Use a commercially available, noncorrosive, non-conductive terminal coating, or petroleum jelly.
- Never use a fast charger as a booster to start the vehicle. This can seriously damage sensitive electronic components such as relays, radio, etc., as well as the battery charger. Fast charging a battery is dangerous and should only be attempted by a competent technician with the proper equipment.

- Charger cables
- 12 V power source

 **WARNING**

Always connect the battery terminals from positive (+) to positive (+) and from negative (-) to negative (-). Improperly attaching the jumper cables or failing to follow these instructions correctly may result death, personal injury, equipment damage, or property damage.

 **WARNING**

Always make sure the battery charger is OFF before connecting or disconnecting the cable clamps to reduce the danger of explosions and resulting death or personal injury. Do not connect or disconnect charger cables while the charger is operating. Damage to the charging system may occur. Failure to comply may result in death, personal injury, equipment damage, or property damage.



NOTE

Follow the instructions that come with your battery charger.

1. Access the battery terminals, the batteries do not have to be removed from the vehicle.
2. Make sure the battery charger is turned off.
3. Disconnect the battery cables.
4. Connect charger cables. Ensure you connect positive to positive (+ to +) and negative to negative (- to -).
5. Start charging the battery at a rate not over 6 amperes. Normally, a battery should be charged at no more than 10 percent of its rated capacity.
6. After charging, turn OFF the charger and disconnect charger cables.

Jump-Starting 12 V Batteries

Required tools:

- Jumper cables
- 12 V power source

Slow Battery Charging

Required tools:



WARNING

Remove any personal jewelry that may come in contact with the battery terminals. Failure to comply may result in death, personal injury, equipment damage, or property damage.



WARNING

DO NOT connect any components to the high-voltage batteries. Only low-voltage batteries can be used for jump-starting the vehicle. Failure to comply will result in death, personal injury, equipment damage, or property damage.



WARNING

NEVER jump-start a vehicle near fire, flames, or electrical sparks. Batteries can generate flammable gases. Maintain sparks, flames, and lighted cigarettes away from the batteries. Failure to comply may result in death, person-

al injury, equipment damage, or property damage.



WARNING

DO NOT ignore any safety procedure as the battery can overheat and catch fire or explode. Failure to comply may result in death, personal injury, equipment damage, or property damage.

To jump-start a 12 V battery system, you can use a battery jump starter, a compatible charger, or power source that puts out 12 V. The instructions below describe a jump-start with another vehicle.

1. Select a jumper cable that is long enough to be attached to both vehicles so that the vehicles do not touch each other.
2. Position the two vehicles together, but do not allow them to touch.
3. Turn OFF all the accessories on both vehicles.
4. Set the parking brakes by pulling the park brake knob back.
5. Shift the Vehicle Mode into neutral.
6. If either vehicle is equipped with a 12 V Disconnect switch, ensure

they are in the OFF position prior to connecting the two vehicles.

7. Locate the positive (+) and negative (-) terminals on the discharged 12 V battery.



WARNING

Always connect the battery terminals from positive (+) to positive (+) and from negative (-) to negative (-). Improperly attaching the jumper cables or failing to follow these instructions correctly may result death, personal injury, equipment damage, or property damage.

8. Attach one end of a jumper cable to the positive (+) terminal of the discharged (dead) battery. This terminal may have a large red + or P on the battery case, post, or clamp.
9. Attach the other end of the same cable to the positive (+) terminal of the charged battery.
10. Attach the remaining jumper cable FIRST to the negative (-) terminal (black or N) of the charged battery.

11. Attach the other end of the negative cable to the negative (-) terminal (black or N) of the discharged battery.
12. Shift the battery disconnect switch to the ON position.
13. Start the vehicle that has the charged battery first and let it run for five minutes.
14. Start the vehicle that has the discharged battery next. The vehicle will start and is ready to operate.
15. Remove the jumper cables.

If the vehicle fails to turn on, do not continue to attempt to turn on the vehicle. Instead, contact the nearest EV service certified dealership. See [Service Locations](#) on page 78.

High-Voltage Batteries

HV State of Health (SOH) Calibration

The State of Health (SOH) calibration must be performed every year to increase

battery life. Follow the next procedure to fully calibrate the SOH of your batteries.

1. Discharge as close to 0% SOC as possible (within 5%, but not 0%).
 2. Turn the start switch off, but leave the 12 V Disconnect switch on for 90 minutes.
 3. Charge to 100% in a single charge.
- Once the SOH has been calibrated, ensure to fully charge or discharge your vehicle in your routine.

HV Battery Storage

Battery Storage Requirements Summary			
Storage Conditions	Duration		
	Up to 7 Days	8 to 30 Days	Over 30 Days
State of Charge (SOC) (Unplugged)	40% to 70%		
Environment	Shaded / covered area (avoid direct sunlight)	Shaded / covered area (avoid direct sunlight)	Shaded / covered area (temperature controlled building recommended)
Temperature inside the battery enclosure	-31°F to 149°F (-35°C to 65°C)	-31°F to 104°F (-35°C to 40°C)	-31°F to 104°F (-35°C to 40°C)
Parking brake	Engaged		

Battery Storage Requirements Summary			
Storage Conditions	Duration		
	Up to 7 Days	8 to 30 Days	Over 30 Days
12 V disconnect switch	Open (12 V OFF)		

Battery Storage Requirements Actions	
Condition	Action
If the vehicle is parked for 90 days or more	Drive the vehicle until SOC displays 0-5%, park with 12 V disconnect switch ON for 90 minutes, and then fully charge.
If the State of Charge (SOC) is below 40%	Plug the vehicle into a charger to bring the State of Charge (SOC) to 40%-70%, but keep the vehicle with the start switch in the ON position for at least 90 minutes to get an accurate SOC. ¹⁰ Inspect the battery level every 14 days.
If the batteries are exposed to temperatures below 32°F (0°C) or above 104°F (40°C) at any time	Plug the vehicle into a charger. If the vehicle is charging properly, the charge port LED will illuminate depending on vehicle status charging and the Digital Display will activate the charging gauges. If the vehicle is not charging, do not unplug the charger. The colder the weather is, the more time the battery needs to charge. ¹¹

¹⁰ The SOC will not change within 1 hour when starting the vehicle after being parked with the 12 V disconnect switch OFF. Even if cell voltage is very low, SOC remains the same.



NOTE

The vehicle deactivates functionalities at 8% SOC to save battery life, but is still drivable so you can get to a charger or safe place to park. At 0% SOC, the vehicle will shut down automatically to prevent damage.



WARNING

DO NOT open the high-voltage battery enclosure for any reason. The battery packs are part of the high-voltage system and do not contain operator-serviceable items. Please contact or take the vehicle to an authorized EV service certified dealership for service. Failure to comply may result in death, personal injury, equipment damage, or property damage.

Single Point Disconnect Switch



WARNING

DO NOT attempt to repair any part of the high-voltage electrical system and components. The high-voltage electrical system is capable of producing electric shock and serious burns. Contact an EV service certified dealership for service. Failure to comply may result in death, personal injury, equipment damage, or property damage.



WARNING

DO NOT attempt maintenance or repair work on the e-powertrain system. The only tasks that can be performed by an operator on this system are visual inspections. Only an EV service certified dealership is authorized to service the vehicle. Failure to comply may

result in death, personal injury, equipment damage, or property damage.



NOTE

DO NOT attempt maintenance or repair work on the e-powertrain system. The only tasks that can be performed by an operator on this system are visual inspections. Only an EV service certified dealership is authorized to service the vehicle. Failure to comply may result in death, personal injury, equipment damage, or property damage.

¹¹ Do not plug in the vehicle if the vehicle has been previously exposed to extreme temperatures and at the time of driving has warmed to 70°F (21°C). Park in a garage or shaded area until battery temperature decreases.



WARNING

Electric vehicles utilize a high-voltage electrical system that has the potential to cause severe injury or death if proper safety precautions are not followed. Carefully read and understand all instructions and hazard alert messages. Failure to comply may result in death, personal injury, equipment damage, or property damage.

The single point disconnect switch is used to de-energize the vehicle for servicing or repair, and only an EV service certified dealership can unlock the padlock. A dual low-voltage power system supports the single point disconnect switch; both low-voltage power routings are connected with the single point disconnect switch. One low-voltage power routing provides power to all contactors in the battery system. The other low-voltage power provides power to the (BMS).

Service Locations

This vehicle requires service that can ONLY be performed by an EV service

certified dealership. Some of the safety messages included in this manual instruct to contact a PACCAR service center when an issue arises with the vehicle. If a service involving the high-voltage system is needed, you should visit <https://www.peterbilt.com/find-a-dealer> or <https://www.kenworth.com/dealers> to find the location of EV service certified dealerships. For any questions or issues regarding the vehicle, call:

- **1-800-KW-Assist (1-800-592-7747) or 1-800-4Peterbilt (800-473-8372)**



WARNING

DO NOT attempt to service this vehicle. Only an EV service certified dealership is authorized to service a PACCAR electric vehicle (EV). EVs use high voltage, posing additional hazards not present when servicing a conventional vehicle. Servicing high voltage components requires proper training, tools, and equipment. **Visual inspections are the only tasks that should be performed by the operator.** Failure to comply may result in

death, personal injury, equipment damage, or property damage.



WARNING

If any issues involving the high-voltage electrical system are discovered, DO NOT drive the vehicle. Please contact or take the vehicle to an authorized EV service certified dealership for service. Failure to comply may result in death, personal injury, equipment damage, or property damage.



WARNING

DO NOT attempt to diagnose or correct any vehicle issues related to the high-voltage electrical system or components. Please contact or take the vehicle to an authorized EV service certified dealership for service. Attempting to diagnose or correct vehicle issues may result in death, personal injury, equipment damage or property damage.

**WARNING**

Ensure any modifications to the vehicle DO NOT affect the high-voltage system. A modification could affect the high voltage electrical system, resulting in electric shock, burns or even death, and will void the warranty. Failure to comply may result in death, personal injury, equipment damage, or property damage.

Chapter 6 | SPECIFICATIONS

Specifications Information.....	81
E-Motor Oil Specifications.....	81
E-Motor Coolant Specifications.....	81

Specifications Information

DO NOT attempt to perform any servicing or repair to an electric vehicle. Service tasks must be performed and decommissioned ONLY by an EV service certified dealership with the proper Personal Protective Equipment (PPE) and facilities. The specifications contained in the following pages are for informational purposes only, and operators must not touch any part of the vehicle high-voltage system as you can receive an electric shock.

E-Motor Oil Specifications

To maintain the motor performance and durability, use the PACCAR recommended ZF Ecofluid E SAE 75W-70 28A.

The oil must be changed every 2 years or every 74,565 mi (120,00 km) if generally used under the following conditions:

- Hot country use: areas where the monthly average temperature exceeds 77°F (25°C) in more than two months within a year, or if temperatures rise above 104°F

(40°C) or more than seven days in a year.

- Scheduled routes (city and suburban operation).
- Short-distance transport.
- Tough operating conditions.
- Average speed from 12.4 to 37.2 mi (20 to 60 km).



WARNING

DO NOT attempt to service this vehicle. Only an EV service certified dealership is authorized to service a PACCAR electric vehicle (EV). EVs use high voltage, posing additional hazards not present when servicing a conventional vehicle. Servicing high voltage components requires proper training, tools, and equipment. **Visual inspections are the only tasks that should be performed by the operator.** Failure to comply may result in death, personal injury, equipment damage, or property damage.



CAUTION

Always follow PACCAR's recommendations to ensure that the e-motor and other electric powertrain components are not affected by using different oil and lubricants specifications. Failure to comply may result in equipment or property damage.

E-Motor Coolant Specifications

The e-motor must maintain an optimum temperature while operating, and the coolant that PACCAR recommends is G40 Water/Glycol (50/50).



WARNING

DO NOT attempt to service this vehicle. Only an EV service certified dealership is authorized to service a PACCAR electric vehicle (EV). EVs use high voltage, posing additional hazards not present when servicing a conventional vehicle. Servicing high voltage components requires proper training, tools, and equipment. **Visual inspections are the only tasks that should be performed by the operator.** Failure to comply may result in death, personal injury, equipment damage, or property damage.



CAUTION

Always follow PACCAR's recommendations to ensure that the e-motor and other electric powertrain components are not affected by using different oil and lubricants specifications. Failure to comply may result in equipment or property damage.

Chapter 7 | INFORMATION

United States and Canada Zero Emission Powertrain Warranty.....	85
Consumer Information.....	90

United States and Canada Zero Emission Powertrain Warranty

Powertrain Warranty for Standard Duty Applications

PACCAR Powertrains Warranted

This warranty applies to new PACCAR Powertrain sold and used in the United States¹² or Canada and operated in on-highway applications. The PACCAR Powertrain is warranted directly to the first purchaser or first lessee by PACCAR.

Base Powertrain Warranty

This warranty coverage is provided for three years or 50,000 miles (80,000 kilometers), whichever occurs first, from the date of delivery of the vehicle to the first purchaser or first lessee. Where a Warrantable Condition exists, PACCAR will diagnose and repair the vehicle, parts and labor included, at no cost to the first

purchaser or first lessee and each subsequent purchaser or lessee. This warranty does not override any extended warranty purchased to cover specific vehicle components.

PACCAR and Owner Responsibilities

PACCAR Responsibilities

PACCAR will pay for all parts and labor needed to repair the damage to the powertrain resulting from a warrantable failure.

PACCAR will pay for the lubricating oil, filter elements, hoses, and other maintenance items that are not reusable due to the warrantable failure.

PACCAR will pay for reasonable labor costs for powertrain removal and reinstallation when necessary to repair a warrantable failure.

PACCAR will not pay any cost for towing a vehicle.

Owner Responsibilities

The owner is responsible for the operation and maintenance of the powertrain as

specified in the applicable PACCAR Operator's Manual. The owner is also responsible for providing proof that all recommended maintenance has been performed.

Before the expiration of the applicable warranty, the owner must notify a PACCAR authorized powertrain dealer of any warrantable failure and make the powertrain available for repair by such facility. The warrantable failure must be brought to the attention of a PACCAR authorized powertrain dealer within 30 days of discovery. Except for powertrains disabled by a warrantable failure, owner must also deliver the powertrain to the repair facility.

The owner is responsible for the cost of lubricating oil, filter elements, and other maintenance items provided during warranty repairs unless such items are not reusable due to the warrantable failure.

The owner is responsible for communication expenses, meals, lodging and similar costs incurred as a result of a warrantable failure.

The owner is responsible for non-powertrain repairs and for "downtime"

¹² United States includes American Samoa, the Commonwealth of Northern Mariana Islands, Guam, Puerto Rico, and the U.S. Virgin Islands.

expenses, cargo damage, towing, fines, all applicable taxes, all business costs and other losses resulting from a warrantable failure.

Warranty Limitations - Standard Duty Applications

Your sole and exclusive remedy against PACCAR and the selling dealer arising from your purchase and use of this powertrain is limited to the repair or replacement of “warrantable failures” at authorized United States and Canadian PACCAR powertrain dealers, or an authorized PACCAR powertrain facility where applicable, subject to PACCAR’s time and mileage limitations of the powertrain warranty. The maximum time and mileage limitations of the powertrain warranty begin running on the date of delivery to the first purchaser or first lessee. The accrued time or mileage is calculated when the powertrain is brought into an authorized dealer for correction of warrantable failures.

Failures, other than those resulting from defects in material or factory workmanship, are not covered by this warranty. PACCAR is not responsible for failures or damage resulting from what PACCAR determines to be abuse or neglect, including, but not

limited to: damage due to accident; operation without adequate coolants or lubricants; overspeeding; lack of maintenance of lubricating, cooling; improper storage, starting, run-in or shutdown practices; unauthorized modifications of the powertrain. PACCAR is also not responsible for failures caused by water, dirt or other contaminants in the powertrain system. Failure of replacement parts used in repairs due to the above non-warrantable conditions is not warrantable. This warranty does not apply to accessories supplied by the vehicle original equipment manufacturer (OEM) which are covered by the OEM vehicle warranty. Failures of hoses supplied by PACCAR are covered for the first year from the date of delivery of the powertrain to the first purchaser or first lessee. Parts used to repair a warrantable failure may be new parts, approved rebuilt parts, or repaired parts. PACCAR is not responsible for failures resulting from the use of parts not approved by PACCAR. A new approved or rebuilt part used to repair a warrantable failure assumes the identity of the part it replaced and is entitled to the remaining coverage hereunder.

PACCAR is not responsible for damage or loss resulting from powertrain horsepower/torque upgrades.

PACCAR reserves the right to interrogate electronic control module (ECM) data for purposes of failure analysis.

PACCAR DOES NOT COVER WEAR OR WEAROUT OF COVERED PARTS. THIS WARRANTY AND THE ZERO EMISSION POWERTRAIN WARRANTY SET FORTH HEREINAFTER ARE THE SOLE WARRANTIES MADE BY PACCAR IN REGARD TO THESE POWERTRAINS. THIS LIMITED WARRANTY IS THE SOLE WARRANTY MADE BY PACCAR AND THE SELLING DEALER. EXCEPT FOR THE ABOVE LIMITED WARRANTY, PACCAR AND THE SELLING DEALER MAKE NO OTHER WARRANTIES, EXPRESS OR IMPLIED. PACCAR AND THE SELLING DEALER EXPRESSLY DISCLAIM ANY WARRANTY OF MERCHANTABILITY OR WARRANTY OF FITNESS FOR A PARTICULAR PURPOSE. PACCAR AND THE SELLING DEALER SHALL NOT BE LIABLE FOR INCIDENTAL OR CONSEQUENTIAL DAMAGES INCLUDING, BUT NOT LIMITED TO: LOSS OF INCOME OR LOST PROFITS; POWERTRAIN OR

VEHICLE DOWNTIME; THIRD PARTY DAMAGE, INCLUDING DAMAGE OR LOSS TO OTHER POWERTRAINS, VEHICLES OR PROPERTY, ATTACHMENTS, TRAILERS AND CARGO; LOSS OR DAMAGE TO PERSONAL CONTENTS; COMMUNICATION EXPENSES; LODGING AND/OR MEAL EXPENSES; FINES; APPLICABLE TAXES OR BUSINESS COSTS OR LOSSES; ATTORNEYS' FEES; AND ANY LIABILITY YOU MAY HAVE IN RESPECT TO ANY OTHER PERSON OR ENTITY.

Zero Emission Powertrain Warranty

The following warranties apply to new PACCAR powertrain marketed by PACCAR that are used in the United States¹³ and Canada in vehicles designed for transporting people or property on a street or highway.

Coverage

PACCAR warrants to the first purchaser or first lessee and each subsequent purchaser that the powertrain is designed,

built, and equipped so as to conform at the time of sale by PACCAR that it is free from defects in material or factory workmanship which would cause it not to meet CARB Zero Emission Powertrain regulation within the longer of the three years or 50,000 miles (80,000 kilometers) of operation, whichever occurs first, as measured from the date of delivery of the powertrain to the first purchaser or first lessee.

If the vehicle in which the powertrain is installed is registered in the state of California, a separate [California Zero Emission Powertrain Control Warranty Statement](#) on page 87 also applies. See California Emissions Warranty.

Replacing Zero Emission Powertrain Related Parts

PACCAR recommends that any service parts used for maintenance, repair, or replacement of emission control systems be new or genuine-approved rebuilt parts and assemblies, and that the powertrain be serviced by an authorized PACCAR powertrain dealer. The use of non-genuine aftermarket parts, auxiliary devices, or electric powertrain consumables may result

in failures, which will not be covered under the manufacturer's warranty. PACCAR does not evaluate all aftermarket auxiliary devices, accessories or consumables promoted by other manufacturers and their effect on PACCAR Products. Customers who use such items assume ALL risk related to the effects that result from this usage.

California Zero Emission Powertrain Control Warranty Statement

Owner's Warranty Responsibilities

As the powertrain owner, you are responsible for the performance of the required maintenance listed in your PACCAR operator's manual. You are responsible for presenting your powertrain to an authorized PACCAR powertrain dealer as soon as a problem exists. The warranty repairs should be completed in a reasonable amount of time, not to exceed 30 days.

PACCAR recommends that you retain all receipts covering maintenance on your

¹³ United States includes American Samoa, the Commonwealth of Northern Mariana Islands, Guam, Puerto Rico, and the U.S. Virgin Islands.

powertrain, but PACCAR cannot deny warranty solely for the lack of receipts or for the failure to ensure the performance of all scheduled maintenance.

As the powertrain owner, you should also be aware that PACCAR may deny you warranty coverage if your powertrain or a part has failed due to abuse, neglect, improper maintenance or unapproved modifications.

If you have any questions regarding your warranty rights and responsibilities, you should contact Kenworth Truck Company 1-425-828-5000, Peterbilt Motor Company at 1-940-591-4220, or the California Air Resources Board at:

California Air Resources Board, 4001
Iowa Avenue, Riverside, CA 92507

A warranted part which is scheduled for replacement as required maintenance is warranted up to the first scheduled replacement point.

Prior to the expiration of the applicable warranty, the owner must give notice of any warranted zero emission powertrain control failure to an authorized PACCAR powertrain dealer and deliver the powertrain to such facility for repair.

The owner is responsible for incidental costs such as: communication expenses, meals, lodging incurred by owner or employees of owner as a result of a warrantable condition.

The owner is responsible for downtime expenses, cargo damage, fines, all applicable taxes, all business costs, and other losses resulting from a warrantable condition.

Replacement Parts

PACCAR recommends that any service parts used for maintenance, repair or replacement of emission control systems be new or genuine PACCAR approved rebuilt parts and assemblies, and that the powertrain be serviced by an authorized PACCAR powertrain dealer. Your vehicle contains air and electrical components that may affect powertrain emission controls. The use of non-genuine powertrain or vehicle replacement parts that are not equivalent to the PACCAR powertrain or OEM vehicle manufacturer's original part may impair the powertrain and vehicle emissions control system from working or functioning effectively, and may jeopardize your emissions warranty coverage.

The owner may elect to have maintenance, replacement or repair of the emission

control parts performed by a facility other than an authorized PACCAR powertrain dealer and may elect to use parts other than new or genuine-approved rebuilt parts and assemblies for such maintenance, replacement or repair; however, the cost of such service or parts and subsequent failures resulting from such service or parts will not be covered under this zero emission powertrain control system warranty, except for [Emergency Repairs](#) on page 88.

PACCAR Responsibilities

The warranty coverage begins when the powertrain is delivered to the first purchaser or first lessee. Repairs and service will be performed by any authorized PACCAR powertrain dealer using new or genuine PACCAR approved rebuilt parts and assemblies. PACCAR will repair any of the emission control parts found by PACCAR to be defective without charge for parts or labor (including diagnosis which results in determination that there has been a failure of a warranted emission control part).

Emergency Repairs

In the case of an emergency where an authorized PACCAR powertrain dealer is

not available, some repairs may be performed by an available repair location or by an individual using replacement parts, however only PACCAR BEV technicians can service the vehicle. PACCAR will reimburse the owner for expenses (including diagnosis), not to exceed the manufacturers suggested retail price for all warranted parts replaced and labor charges based on the manufacturers recommended time allowance for the warranty repair and the geographically appropriate hourly labor rate.

Warranty Limitations

Your sole and exclusive remedy against PACCAR and the selling dealer arising from your purchase and use of this powertrain is limited to the repair or replacement of “warrantable failures” at authorized United States and Canadian PACCAR powertrain dealers, or an authorized PACCAR powertrain facility where applicable, subject to PACCAR’s time and mileage limitations of the powertrain warranty. The maximum time and mileage limitations of the powertrain warranty begin running on the date of delivery to the first purchaser or first lessee. The accrued time or mileage is calculated when the powertrain is brought

into an authorized dealer for correction of warrantable failures. Failures, other than those resulting from defects in material or factory workmanship, are not covered by this warranty. PACCAR is not responsible for failures or damage resulting from what PACCAR determines to be abuse or neglect, including, but not limited to: damage due to accident; operation without adequate coolants or lubricants; overspeeding; lack of maintenance of lubricating, cooling; improper storage, starting, warm-up, run-in or shutdown practices; unauthorized modifications of the powertrain. PACCAR is also not responsible for failures caused by water, dirt or other contaminants in the powertrain system. Failure of replacement parts used in repairs due to the above non-warrantable conditions is not warrantable. PACCAR is not responsible for failures resulting from improper repair or the use of parts which are not genuine PACCAR approved parts. PACCAR is not responsible for the material and labor costs of zero emission powertrain control parts and assemblies replaced during Scheduled Maintenance of the powertrain as specified in PACCAR Operator’s Manuals.

THIS WARRANTY, TOGETHER WITH THE EXPRESS COMMERCIAL WARRANTIES ARE THE SOLE WARRANTIES MADE BY PACCAR IN REGARD TO THESE POWERTRAINS. THIS LIMITED ZERO EMISSION POWERTRAIN WARRANTY IS THE SOLE WARRANTY MADE BY PACCAR AND THE SELLING DEALER. EXCEPT FOR THE ABOVE LIMITED WARRANTY, PACCAR AND THE SELLING DEALER MAKE NO OTHER WARRANTIES, EXPRESS OR IMPLIED. PACCAR AND THE SELLING DEALER EXPRESSLY DISCLAIM ANY WARRANTY OF MERCHANTABILITY OR WARRANTY OF FITNESS FOR A PARTICULAR PURPOSE PACCAR AND THE SELLING DEALER SHALL NOT BE LIABLE FOR INCIDENTAL OR CONSEQUENTIAL DAMAGES INCLUDING, BUT NOT LIMITED TO: LOSS OF INCOME OR LOST PROFITS; POWERTRAIN OR VEHICLE DOWNTIME; THIRD PARTY DAMAGE, INCLUDING DAMAGE OR LOSS TO OTHER POWERTRAINS, VEHICLES OR PROPERTY, ATTACHMENTS, TRAILERS AND CARGO; LOSS OR DAMAGE TO PERSONAL CONTENTS;

**COMMUNICATION EXPENSES;
LODGING AND/OR MEAL EXPENSES;
FINES; APPLICABLE TAXES OR
BUSINESS COSTS OR LOSSES;
ATTORNEYS' FEES; AND ANY
LIABILITY YOU MAY HAVE IN RESPECT
TO ANY OTHER PERSON OR ENTITY.**

Consumer Information

How To Order Replacement Parts

You can obtain replacement parts from an authorized dealership. When you order, it is **IMPORTANT** that you have the following information ready:

- Name and address
- Serial number of the vehicle
- The name of the part you need
- The name and number of the component for which the part is required
- The quantity (qty) of parts you need
- How you want the order shipped

National Highway Traffic and Safety Administration (NHTSA)

If you believe that the vehicle has a dangerous defect, you must immediately inform the National Highway Traffic Safety Administration (NHTSA). Also notify the vehicle manufacturer. If NHTSA receives similar complaints, it can open an investigation. If it finds that a safety defect exists in a group of vehicles, it can order a recall and remedy campaign. However, NHTSA cannot get involved in individual problems between you, the dealer, and the vehicle manufacturer. Contacting NHTSA is possible through telephone, written mail, and email. NHTSA also has a website where you can input the comments directly to them on the Web. Use any of the four ways to contact NHTSA:

Ex: Toll Free 1-888-327-4236
(800-424-9153 TTY) 8:00 a.m. to 10:00 p.m. EST Monday-Friday

Mail: Office of Defects Investigations/CRD NVS-216 1200 New Jersey Ave. SE Washington, D.C. 20590

Website: www.safercar.gov

Email: nhtsa.webmaster@dot.gov

Transport Canada

Canadian customers must report a safety-related defect to Transport Canada, Defect Investigations and Recalls. You can reach them by telephone on the toll-free hotline at 1-800-333-0510. You can also contact Transport Canada by mail at: Transport Canada, ASFAD Place de Ville Tower C 330 Sparks St. Ottawa, ON K1A 0N5

For additional road safety information, visit the Road Safety website at: <http://www.tc.gc.ca>

Data Recorder

California Vehicle Code - Section 9951 - Disclosure of Recording Device
Your vehicle may be equipped with one or more recording devices commonly referred to as "event data recorders" (EDR) or "sensing and diagnostic modules" (SDM). If you are involved in an accident, the device(s) may have the ability to record vehicle data that occurred just prior to and/or during the accident. For additional

information on your rights associated with the use of this data, contact:

- The California Department of Motor Vehicles - Licensing Operations Division
- <http://www.dmv.ca.gov/>

Index

Numerics

12 V Battery [38](#)

A

Air Compressor [59](#)

Air filter Cartridge Replacement [67](#)

Air Filter Housing Replacement [67](#)

B

Batteries, 12 V Disconnect [42](#)

Battery Balancing [17](#)

Battery Box [24](#)

Battery Electric Vehicle (BEV) Badge [8](#)

Battery Electric Vehicle (BEV) Safety Labels [6](#)

Battery Electric Vehicle (BEV) Zero Emissions Powertrain [15](#)

Battery Electrical Vehicle (BEV) Components [15](#)

Battery Gauge and Estimated Range [16](#)

Battery Management System (High Voltage) [16](#)

BEV Safety Labels [8](#)

C

Cab Pump [29](#)

California Zero Emission Powertrain Control Warranty Statement [87](#)

Cell Supervisory Circuit (CSC) [23](#)

Cells [22](#)

Charge Control Unit (CCU) [25](#)

Charge Inlet (CI) [25](#)

Charge Plug Connect [39](#)

Charge Target [52](#)

Charging Considerations [46](#)

Charging Management System [24](#)

Charging Status [47](#)

Check Power Steering Fluid Level [68](#)

Cleaning Vacuum Oil Drainage [64](#)

Coalescing Filter Replacement [65](#)

Control Plug-in Charge [49](#)

Coolant Heater [28](#)

D

Daily Inspections [60](#)

Dash Switches [41](#)

DC-DC Converter [20](#)

Degraded Regenerative Braking [32](#)

Disconnecting the Charger [49](#)

Drain Power Steering Fluid [70](#)

E

E-Fan [27](#)

E-Fan (High Voltage) [58](#)

E-Motor [29](#)

E-Motor (High Voltage) [58](#)

E-Motor Coolant Specifications [81](#)

E-Motor Oil Specifications [81](#)

E-Motor Shift Transmission [30](#)

Electric Refrigerant Compressor (High Voltage) [27](#)

Electric Traction Motor System (High Voltage) [29](#)

Emergency Repairs [88](#)

Energy Storage System [21](#)

Equipotential Bonding [20](#)

G

General Safety Labels [8](#)

H

High Voltage (HV) Battery String [21](#)
High Voltage Junction Box (HVJB) [19](#)
High-Voltage (HV) Safety Labels [11](#)
High-Voltage Batteries [59](#)
High-Voltage Hazard [39](#)
HV Battery Storage [75](#)
HV State of Health (SOH) Calibration [75](#)

I

Illustrations [13](#)
Initiating a Charge [45](#)
Inverter [33](#)

J

Jump-Starting 12 V Batteries [73](#)

L

Lithium-Iron Phosphate Battery [22](#)
Low Voltage Batteries [71](#)
Low-Voltage Disconnect (LVD) [39](#)

M

Master Battery Management Unit (BMU) [20](#)
Master Service Disconnect (MSD) [18](#)
Move Disallowed [40](#)

O

On-Board Charger (OBC) (Optional) [25](#)

P

PACCAR and Owner Responsibilities [85](#)
PACCAR Responsibilities [88](#)
PCAS Maintenance [67](#)
PCAS Maintenance Schedule [62](#)
Preconditioning [53](#)
Prescheduling [50](#)
Preventive Maintenance [57](#)
Products Warranted [85](#)
Proportional Coolant Valve [29](#)

R

Ready to Move [40](#)
Refilling Air Compressor Oil [63](#)
Regenerative Braking [40](#)
Regenerative Braking Fault [33](#)
Regenerative Braking Indicator [32](#)
Regenerative Braking Operation [32](#)
Regenerative Braking System [31](#)
Regenerative Braking System (RBS) Fault [40](#)
Regenerative Braking Unavailable [33](#)
Relay Box [17](#)
Replacement Parts [88](#)
Replacing Zero Emission Powertrain Related Parts [87](#)
Right-Hand Controls [42](#)

S

S-Box [19](#)
Safety Messages and Notes [5](#)
Scheduled Charging [51](#)
Service Locations [78](#)
Service Vehicle [41](#)
Setting Planned Departure [54](#)
Single Point Disconnect Switch [77](#)
Slave Battery Management Unit (BMU) [19](#)
Slow Battery Charging [73](#)
Specifications Information [81](#)
Starting up [49](#)
State of Charge (SOC) [23](#), [41](#)
State of Health (SOH) [23](#)
Stop Charging [42](#)
Stop Charging Switch [49](#)

T

Thermal Management System [26](#)
TXV-Chiller [28](#)

U

Using this Manual [5](#)

V

Vehicle Warm-Up [50](#)

W

Warning Lights and Indicators [37](#)
Warranty Limitations [89](#)

Warranty Limitations - Standard Duty Applications [86](#)

Z

Zero Emission Powertrain Warranty [87](#)

PACCAR INC.

P.O. Box 1518
Bellevue, WA 98009

Do not remove the manual from vehicle.
Before operating vehicle study the manual carefully.
Read and understand all warnings, cautions and notes.

Y53-6220-1A1

Printed in the U.S.A. 10/24