

PACCAR ENGINES

PX-7

Operator's Manual

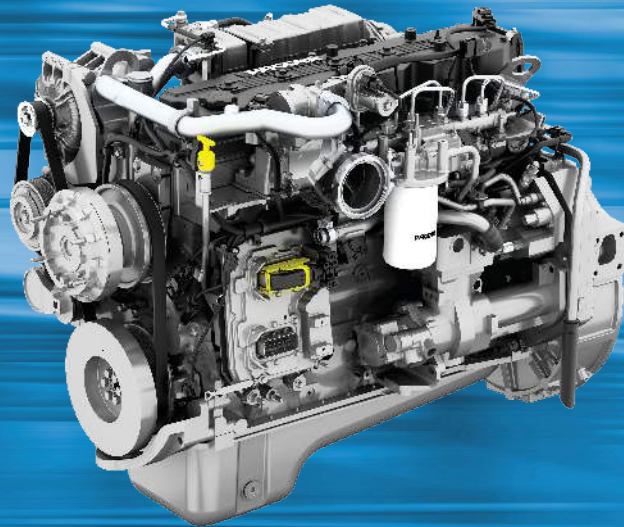

2024 Emissions
2024 Model Year Warranty

PX Operator Manual

PACCAR PX-7 Engine

Engine Operation

1

Engine Maintenance

2

Engine Warranty

3

© 2023 PACCAR Inc. - All Rights Reserved

This manual illustrates and describes the operation of features or equipment which may be either standard or optional on this vehicle. This manual may also include a description of features and equipment which are no longer available or were not ordered on this vehicle. Please disregard any illustrations or descriptions relating to features or equipment which are not on this vehicle. PACCAR reserves the right to discontinue, change specifications, or change the design of its vehicles at any time without notice and without incurring any obligation. The information contained in this manual is proprietary to PACCAR. Reproduction, in whole or in part, by any means is strictly prohibited without prior written authorization from PACCAR Inc.

Chapter 1 | ENGINE OPERATION

Safety - Introduction.....	5
Emergency - What To Do If.....	9
Operating Instructions.....	13

Safety - Introduction

Using this Manual

Please take the time to get acquainted with your vehicle by reading this Operator's Manual. We recommend that you read and understand this manual from beginning to end before you operate this equipment. This manual contains useful information for the safe and efficient operation of this equipment. It also provides service information, with an outline for performing safety checks and basic preventive maintenance inspections. When replacement parts are needed, we recommend using only genuine PACCAR parts. We have tried to present the information needed to learn about functions, controls, and operation—and to present it as clearly as possible. Occasionally, you may need to reference this manual, and we hope you find it easy to use.

NOTE

After you have read this manual, it should be stored in the cab for convenient reference and remain with this truck when sold.

Your vehicle may not have all the features or options mentioned in this manual. Therefore, you should pay careful attention to the instructions that pertain to just your vehicle. In addition, if your vehicle is equipped with special equipment or options not discussed in this manual, consult your dealer or the manufacturer of the equipment. There are several tools built into this manual to help you find what you need quickly and easily; first is the Table of Contents. Located at the front of the manual, this table arranges the subject matter into chapters, which can be quickly referenced using the numbers shown in the outer margin. The first page of each chapter presents a list of the major subjects contained in that chapter. Cross-referenced citations can also help you find information. If more information on the current subject is located elsewhere in the

manual, a cross-reference may be provided, such as "see *Safety Messages and Notes* on page 5." Finally, you will find a helpful index at the back of the manual which lists the subjects covered alphabetically.

All information contained in this manual is based on the latest production information available at the time of publication. If you find differences between your instruments and the information in this manual, contact a PACCAR Powertrain distributor. PACCAR reserves the right to make changes at any time without notice.

Safety Messages and Notes

Read and follow ALL safety messages in this manual. When followed, injury to yourself and others, damage to equipment and/or property, or other unknown hazards are reduced. Both safety messages and notes are emphasized using a safety message symbol and one of three signal words: WARNING, CAUTION, or NOTE. **Do not** ignore any of these messages.

Warnings



Safety messages that follow this symbol and signal word provide a warning concerning operating procedures, actions, or a lack of action that could result in death or injury. An unheeded warning may also result in damage to equipment, property, or the environment. Warning messages will identify the hazard, how to avoid it, and the probable consequence of not avoiding the hazard.

Example:

 WARNING
<p>DO NOT change hot engine oil as you could be burned. Let the engine cool down before changing the engine oil. Failure to comply may result in death, personal injury, equipment damage, or property damage.</p>

Cautions



Safety messages that follow this symbol and signal word provide a caution against operating procedures, actions, or a lack of action that could result in equipment,

property, or environmental damage. Caution messages will identify the hazard, how to avoid it, and the probable consequence of not avoiding the hazard. Example:

 CAUTION
<p>DO NOT operate your vehicle with insufficient oil pressure as this will cause serious engine damage. Failure to comply may result in equipment or property damage.</p>

Notes



Messages that follow this symbol and signal word provide important information that, while not safety related, should still be followed. A note will provide information that may be useful to the reader: clarifying the topic, providing valuable insight into the topic or process, or saving the reader time and effort. Example:

 NOTE
<p>Pumping the accelerator pedal will not assist in starting the engine.</p>

Forward

This manual contains information for the correct operation and maintenance of your PACCAR engine. Read and follow all safety instructions. Read the [General Safety Instructions](#) on page 7 before operating your engine. Keep this manual with the equipment. If the equipment is traded or sold, give the manual to the new owner.

The information, specifications, and recommended maintenance guidelines in this manual are based on information in effect at the time of printing. PACCAR reserves the right to make changes at any time without obligation. If you find differences between your engine and the information in this manual, contact your local PACCAR Authorized Repair Location or write to:

PACCAR c/o PACCAR Engines

PO Box 1518 Bellevue, WA 98009

The latest technology and the highest quality components were used to produce this engine. When replacement parts are needed, we recommend using only genuine parts from PACCAR.



NOTE

Warranty information including the EPA and California Emission Warranty is located in the section entitled "Engine Warranty." Make sure you are familiar with the warranty or warranties applicable to your engine.

Illustrations

Some of the illustrations found in this manual are generic, and may not look exactly like the parts or assemblies you find installed on your vehicle.

When an illustration differs from what you see physically present on your vehicle, the language describing the procedure will still be correct for your application.

General Safety Instructions



WARNING

Improper practices, carelessness, or ignoring safety messages – Warnings and Cautions – may cause death, personal injury, or equipment and property damage.

Before performing any repair, read and understand all of the safety precautions and warnings. The following is a list of general safety precautions that must be followed to provide personal safety. Failure to follow these instructions may cause death or injury. Special safety precautions are included in the procedures when they apply. Keep in mind that even a well-maintained vehicle must be operated within the range of its mechanical capabilities and the limits of its load ratings. See the Weight Ratings label on the driver's door edge. Every new vehicle is designed to conform to all Federal Motor Vehicle Safety Standards applicable at the time of manufacture. Even with these safety features, continued safe and reliable operation depends upon regular vehicle

maintenance. Follow the maintenance recommendations found in the Maintenance section. Following maintenance recommendations will help your vehicle maintain quality conditions. Make sure your vehicle is in top working condition before heading out on the road, it is the driver's duty to do so. Inspect the vehicle according to the Driver's Check List:

- Work areas should be dry, well lit, well ventilated; free from clutter, loose tools, parts, ignition sources, and hazardous substances.
- Wear protective glasses and protective shoes when working.
- Wear protective gloves when working with hot liquids or surfaces, and when working with components that have sharp edges.
- DO NOT wear loose-fitting or torn clothing. Tie back and/or tuck in long hair. Remove all jewelry when working.
- Before beginning any repair, disconnect the battery (negative [-] cable) and discharge any capacitors.

- Put a “DO NOT OPERATE” tag in the operator’s compartment or on the controls.
- Allow the engine to cool before slowly loosening the coolant fill cap to relieve the pressure from the cooling system.



WARNING

Removing the fill cap on a hot engine can cause scalding coolant to spray out and burn you badly. If the engine has been in operation within the previous 30 minutes, be very careful in removing the fill cap. Protect face, hands, and arms against escaping fluid and steam by covering the cap with a large, thick rag. DO NOT try to remove it until the surge tank cools down or if you see any steam or coolant escaping. Always remove the cap very slowly and carefully. Be ready to back off if any steam or coolant begins to escape. Failure to comply may result in death, personal injury, equipment or property damage.

- Always use wheel chocks or proper jack stands to support the vehicle

or vehicle components before performing any service work. DO NOT work on anything that is supported only by lifting jacks or a hoist. Before resting a vehicle on jack stands, be sure the stands are rated for the load you will be placing on them.

- Before removing or disconnecting any lines, fittings, or related items, relieve all pressure in the air, oil, fuel, and cooling systems. Remain alert for possible pressure when disconnecting any device from a system that contains pressure. High-pressure oil or fuel can cause death or personal injury.
- Always wear protective clothing when working on any refrigerant lines and make sure that the workplace is well ventilated. Inhalation of fumes can cause death or personal injury. To protect the environment, liquid refrigerant systems must be properly emptied and filled using equipment that prevents the release of refrigerant gas. Federal law requires capturing and recycling refrigerant.
- When moving or lifting any heavy equipment or parts, make sure to

use proper techniques and assistance. Ensure all lifting devices such as chains, hooks, or slings are in good condition and are rated for the correct load capacity. Make sure all lifting devices are positioned correctly.

- Corrosion inhibitors and lubricating oils may contain alkali. DO NOT get the substance in eyes and avoid prolonged or repeated contact with skin. DO NOT swallow. If ingested, seek immediate medical attention. DO NOT induce vomiting. In case of contact, immediately wash skin with soap and water. In case of harmful contact, immediately contact a physician. Always keep any chemicals OUT OF REACH OF CHILDREN.
- When working on the vehicle, be alert for hot parts on systems that have just been turned off, exhaust gas flow, and hot fluids in lines, tubes, and compartments. Contact with any hot surface may cause burns.
- Always use tools that are in good condition. Make sure you have the proper understanding of how to use

the tools before performing any service work. Use only genuine replacement parts from PACCAR.

- Always use the same fastener part number (or equivalent) when replacing items. DO NOT use a fastener of lesser quality if replacements are necessary. (e.g., DO NOT replace a Metric 10.9 grade with 8.8 grade fastener).
- Always torque fasteners and fuel connections to the required specifications. Overtightening or under-tightening can allow leakage.
- Close the manual fuel valves prior to performing maintenance and repairs, and when storing the vehicle inside.
- DO NOT perform any repair when impaired, tired, fatigued, or after consuming alcohol or drugs that can impair your functioning.
- Some state and federal agencies in the United States of America have determined that used engine oil can be carcinogenic and can cause reproductive toxicity. Avoid inhalation of vapors, ingestion, and prolonged contact with used engine oil.

- Coolant is toxic. If not reused, dispose of coolant in accordance with local environmental regulations.



CAUTION

Corrosive chemicals can damage the engine. DO NOT use corrosive chemicals on the engine. Failure to comply may result in equipment or property damage.

California Proposition 65 Warning

- Diesel engine exhaust and some of its constituents are known to the State of California to cause cancer, birth defects, and other reproductive harm.
- The catalyst substrate located in the Diesel Particulate Filter (DPF) contains vanadium pentoxide, which has been determined by the State of California to cause cancer. Always wear protective clothing and eye protection when handling the catalyst assembly. Dispose of the catalyst in accordance with local regulations. If catalyst material gets into the eyes,

immediately flood eyes with water for a minimum of 15 minutes. Avoid prolonged contact with skin. In case of contact, immediately wash skin with soap and water. In case of harmful contact, immediately contact a physician.

- Other chemicals in this vehicle are also known to the State of California to cause cancer, birth defects, or other reproductive harm.
- Battery posts, terminals, and related accessories contain lead and lead compounds, chemicals known to the State of California to cause cancer and reproductive harm. Wash hands after handling.

Emergency - What To Do If

Roadside Assistance

Open 24 hours a day, 365 days a year, call toll-free to talk to someone at the PACCAR Vehicle Support Center:

- Kenworth customers
1-800-KW-Assist
(1-800-592-7747)
- Peterbilt customers

**1-800-4Peterbilt
(1-800-473-8372)**

The PACCAR Vehicle Support Center

- Uses a custom mapping system that locates PACCAR Powertrain distributors and Independent Service Providers (ISPs) near you, listing services offered, hours of operation, and contact information.
- Assists with jump and pull starts, tires, trailers, fines and permits, chains, towing, hazardous clean-up, out of fuel (roadside), mechanical repairs and preventive maintenance services.
- Employs multilingual agents and has access to a translation service, ensuring quality assistance for customers in many languages.
- Places you in contact with a PACCAR Powertrain distributor who can answer your warranty questions.
- Provides these services for FREE.

Stop Engine Lamp

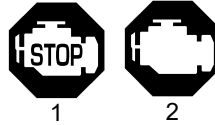

The stop engine warning lamp will illuminate, and an audible tone will sound, when a major engine problem exists. Your vehicle will be equipped with one of the indicators above, 1 or 2, depending on the engine model.



WARNING

If the Stop Engine warning lamp illuminates, it means you have a serious engine system problem. This should be considered an emergency. You should stop the vehicle as safely as possible and turn OFF the ignition. The vehicle must be serviced and the problem corrected before driving again. Failure to comply may result in death, personal injury, equipment or property damage.

For engines with the engine-protection shutdown feature enabled, the stop engine lamp will begin to flash 30 seconds before the engine automatically shuts down. The

warning lamp alerts the operator to the impending shutdown.

The lamp will also illuminate when the DEF tank is almost empty or the soot level in the DPF is at full capacity. At this level warning, regeneration cannot be performed and engine power will be derated. Engine may automatically shut down if the check engine lamp and stop engine lamp are illuminated and the operator does not correct the condition.

Engine Oil Pressure Lamp Turns On

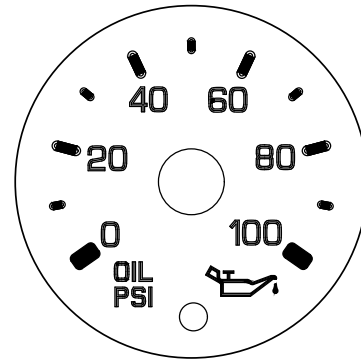

It is important to maintain oil pressure within acceptable limits. If oil pressure drops below the minimum psi a red warning lamp on the oil pressure gauge and the Stop Engine Lamp will come ON.



CAUTION

Continuing to operate your vehicle with insufficient oil pressure will cause serious engine damage. Failure to comply may result in equipment or property damage.

- If the oil pressure fails to rise within 10 seconds after the engine starts, stop the engine and determine the cause.
- See Engine Oil Specification for the correct oil pressure ranges for your vehicle's engine.
- If the oil pressure suddenly drops, or the audible alarm and engine oil pressure warning light come on while driving, do the following:
 1. Slow down carefully.
 2. Move a safe distance off the road and stop.
 3. Place the transmission in neutral (N) and set the parking brake. (See

Parking Brake Valve and Operating the Transmission in your vehicle Operator's Manual, for transmission shifting and parking brake information.)

4. Turn OFF the engine.
5. Turn ON the emergency flasher and use other warning devices to alert other motorists.
6. Wait 15-20 minutes to allow oil to drain into the engine oil pan, and then check the oil level. See [Engine Oil Level](#) on page 55.
7. Add oil if necessary. If the problem persists, contact an authorized PACCAR engine dealer as soon as possible.

Check Engine Lamp Turns On



Or



Check Engine Lamp - Turns on when a problem exists, but the vehicle can still be safely driven. Vehicle should be serviced to correct the problem but the situation should not be considered an emergency. The lamp will also illuminate when a DPF regeneration or addition of diesel exhaust fluid (DEF) is required. Another function of the check engine lamp is to warn the operator of an impending idle shutdown. When the idle shutdown timer is 30 seconds from expiring, the ECM begins flashing the check engine warning lamp once per second. When the timer expires, the ECM will turn off the warning lamp and shut down the engine.

Engine is Overheating





CAUTION

The cooling system may overheat if the engine coolant is at the minimum level. A sudden loss of coolant, caused by a split hose or broken hose clamp could also lead to an overheat condition. Always inspect to ensure hoses and clamps are not cracked, worn, or loose. Failure to comply may result in equipment or property damage.



NOTE

The system may also temporarily overheat during severe operating conditions such as:

- Climbing a hill on a hot day
- Stopping after high-speed/high-load driving
- Debris blocking air flow through the cooling module (radiator)

If the engine coolant temperature warning lamp comes on and the audible alarm sounds showing an overheat condition, or if you have any other reason to suspect the

engine may be overheating, **DO NOT TURN OFF THE ENGINE** unless a low water warning device indicates a loss of coolant.

Follow these steps if the engine coolant temperature is rising, or the temperature is already above normal, and there are no other warning alarms displayed in the instrument cluster.



NOTE

The instrument cluster gauges may appear (if hidden from view), change brightness and change color to bring attention to a particular system.

1. Reduce engine speed, or stop. When stopped, place the transmission in neutral (N) and set the parking brake. Keep the engine running.



WARNING

To reduce the chance of personal injury, vehicle damage, and/or death from overheated engines, which can result in a fire, never leave the engine

idling without an alert driver present. If the engine does overheat, as indicated by the engine coolant temperature lamp, immediate action is required to correct the condition. Continued unattended operation of the engine, even for a short time, may result in serious engine damage or a fire. Failure to comply may result in death, personal injury, equipment or property damage.

**WARNING**

Removing the fill cap on a hot engine can cause scalding coolant to spray out and burn you badly. If the engine has been in operation within the previous 30 minutes, be very careful in removing the fill cap. Protect face, hands, and arms against escaping fluid and steam by covering the cap with a large, thick rag. DO NOT try to remove it until the surge tank cools down or if you see any steam or coolant escaping. Always remove the cap very slowly and carefully. Be ready to back off if any steam or coolant begins to escape. Failure to comply may result in death, personal injury, equipment or property damage.

**NOTE**

Keep the engine running at idle speed unless a warning icon turns on that requires the engine to be shut off.

2. Check to ensure the Oil Pressure Gauge reads normal.

3. Make sure the engine fan is turning by switching the **Engine Fan Switch** from AUTO to MAN (Manual).
4. Idle the engine to see if this reduces the coolant temperature. If the temperature does not begin to drop, shut off the engine and contact your nearest authorized dealer.
5. If the temperature begins to return to normal, allow the engine to idle 3 to 5 minutes before shutting it off. This allows the engine to cool gradually and uniformly.
6. If overheating came from severe operating conditions, the temperature should have cooled by this time. If it has not, stop the engine and let it cool before checking to see if the coolant is low.
7. Be sure the vehicle is parked on level ground or the readings may be incorrect. Check the coolant level at the coolant surge tank.

Check the coolant level after each trip when the engine has cooled. The coolant level should be visible within the surge tank. Add coolant if necessary.

Operating Instructions

Engine Warning Lamps

The following engine warning lamps section covers only the lamps controlled by the engine's Electronic Control Module (ECM). Please refer to the vehicle "Operator's Manual" and "Engine Aftertreatment Systems" manuals for additional warning lamp information.

**CAUTION**

The installation of electronic devices to the On Board Diagnostics (OBD) connector, the vehicle Controller Area Network (CAN), or their associated wiring is not permitted. Doing so can adversely affect vehicle performance and/or cause fault codes to be recorded. The OBD connector is provided for temporary connection of service tools and for diagnostic purposes only. Failure to comply may result in equipment or property damage.

Stop Engine Lamp

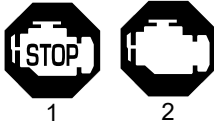

The stop engine warning lamp will illuminate, and an audible tone will sound, when a major engine problem exists. Your vehicle will be equipped with one of the indicators above, 1 or 2, depending on the engine model.



WARNING

If the Stop Engine warning lamp illuminates, it means you have a serious engine system problem. This should be considered an emergency. You should stop the vehicle as safely as possible and turn OFF the ignition. The vehicle must be serviced and the problem corrected before driving again. Failure to comply may result in death, personal injury, equipment or property damage.

For engines with the engine-protection shutdown feature enabled, the stop engine lamp will begin to flash 30 seconds before

the engine automatically shuts down. The warning lamp alerts the operator to the impending shutdown. The lamp will also illuminate when the DEF tank is almost empty or the soot level in the DPF is at full capacity. At this level warning, regeneration cannot be performed and engine power will be derated. Engine may automatically shut down if the check engine lamp and stop engine lamp are illuminated and the operator does not correct the condition.

Engine, Check Engine



Or



Illuminates when a non-emissions related problem exists, but the vehicle can still be safely driven. Vehicle should be serviced to correct the problem but the situation should not be considered an emergency.

Diesel Particulate Filter (DPF)

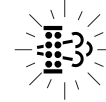

This warning means that the DPF needs to be regenerated and will appear when soot in the DPF exceeds an acceptable amount or a significant amount of hydrocarbons (HC) are detected. This warning may also appear if the system is attempting to regenerate automatically while the vehicle is in Power Take-off (PTO) mode. For more information about this warning, consult the Engine Aftertreatment System operator's manual.

**NOTE**

This manual describes only the most basic aftertreatment information essential for a driver to operate the vehicle safely. A more thorough explanation of your emissions system can be found in the video linked to the QR code below or in the Engine Aftertreatment Systems Operator's Manual.

**High Exhaust System Temperature (HEST)****WARNING**

If the High Exhaust System Temperature (HEST) warning light is on, do not park near people. The heat generated by the engine aftertreatment system (EAS) may cause serious burns if EAS components are contacted. Failure to do so may result in property damage, personal injury, or death.

**WARNING**

If the High Exhaust System Temperature (HEST) warning light is on, do not park near combustible vapors or materials. You must keep combustibles at least 5 ft. (1.5 m) away from the exhaust (outlet) stream as it exits the tail pipe while the HEST light is illuminated. Failure to do so could ignite an explosion and cause death or serious in-

jury to bystanders and may result in property or equipment damage.

**WARNING**

When the High Exhaust System Temperature (HEST) warning light is on, the temperature of the tailpipe, exhaust pipes, diesel particulate filter (DPF)/selective catalytic reduction (SCR) device, and surrounding components (including enclosures and steps) becomes elevated and can cause serious burns to the skin. Allow adequate cooling time before approaching, or working on or near, any part of the exhaust system or surrounding components. Failure to comply may result in death, personal injury, equipment damage or property damage.

The purpose of the High Exhaust System Temperature (HEST) warning light is to notify the operator to high temperatures in the vicinity of the tail pipe, diesel particulate filter (DPF), and surrounding components during a regeneration. The HEST warning light turns on only when the

vehicle is stationary or moving slowly: less than 5 mph (8 kph).

During a regeneration, some EAS components can reach temperatures greater than 1202°F (650°C). Therefore, it is important to pay attention to HEST warnings prior to, during, and immediately following a regeneration.

Diesel Exhaust Fluid (DEF) Lamp

The engine aftertreatment system includes a diesel exhaust fluid (DEF) warning lamp on the DEF gauge and additional warning lamps or notification messages in the instrument cluster. Refer to the operator manual for more details.

The engine aftertreatment system includes diesel exhaust fluid (DEF) warning lamps or notification messages in the instrument cluster. Refer to the operator manual for more details.

DEF Warning Lamp in Instrument Cluster



The system will alert the operator when the fluid in the DEF tank reaches a low level. Refer to the operator manual for more

details. If the lamp illuminates but the level is full, seek service immediately for DEF fluid quality or DEF equipment repair.

Engine Wait-to-Start Light

This warning icon will appear when the system needs some time before attempting to start the engine. The light will illuminate at key ON, and will stay on for a period of up to 30 seconds.



i NOTE

The length of time the 'Wait-To-Start' lamp remains illuminated depends on the ambient temperature. The lower the ambient temperature, the longer the lamp will be illuminated.

Once the Wait-to-Start light turns off, turn the key to the starting position to start the engine.

You may see this appear if the system has detected a situation where the starter is too hot and needs to cool down. Alternatively,

you may see it when the engine grid heater is on and needs some time to warm up.

i NOTE

Some engines are equipped with an engine starting motor protection feature. If the starting motor is engaged for 30 or more seconds, without the engine starting, the starter will be locked out from operating, allowing for proper cooling of the starting motor. During this time, the 'Wait-To-Start' lamp will flash for 2 minutes. Once the lamp stops flashing, the starting motor will be allowed to function.

Exhaust Braking System

An exhaust brake is standard on PX-7 engines. When activated, this device supplements the service brakes by creating a braking effect on the drive wheels, helping keep your vehicle's service brakes from overheating and/or from additional wear and tear. The exhaust brake is not an emergency brake nor intended to replace the service brakes.

**WARNING**

DO NOT use an exhaust brake when driving bobtail or with an unloaded trailer. There may not be enough weight on the rear axle to provide traction. This could cause a loss of control and jackknife resulting in an injury accident. Make sure the exhaust brake is switched "OFF" when driving bobtail or with an unloaded trailer. Failure to comply may result in death, personal injury, equipment or property damage.

**WARNING**

The exhaust brake is not intended as the primary brake for the vehicle, nor is it an emergency brake. The service brakes must be used in an emergency. Relying solely on the exhaust brake to stop the vehicle in an emergency could cause an accident and lead to personal injury. The exhaust brake only helps the service brakes by using pressure to slow the drive train. You must use the service brakes for quick or emergency stops. Failure to comply

may result in death, personal injury, equipment or property damage.

**NOTE**

If your vehicle is equipped with anti-lock brakes (ABS), operation of the exhaust brake (if turned ON) may be interrupted if the ABS system detects wheel-slip due to operation on slippery surfaces.

Ideally (on normal road surfaces), you should slow your vehicle with the exhaust brake (where permitted by law) and use the service brakes only for stopping completely. Operating this way will greatly prolong the life of the service brakes.

Exhaust Brake

Engines equipped with a variable geometry turbocharger (VGT) can possibly be equipped with an optional engine exhaust brake feature. The ON/OFF function would be controlled by a switch located on the dash of the vehicle.

This feature, if the vehicle is equipped, allows the VGT to act as an exhaust brake. An engine exhaust brake retards the speed of the engine during motoring conditions to

provide additional vehicle braking power and extend the life of the vehicle service brakes.

An engine exhaust brake functions by retarding engine speed by creating high exhaust back pressure. This back pressure is obtained by restricting air flow through the turbine housing of the turbocharger. This restriction through the turbine housing of the turbocharger is created through positioning of the sliding nozzle located internally to the VGT. The position of the sliding nozzle is controlled by the engine control module (ECM).

When the engine exhaust brake switch is in the ON position, the ECM monitors inputs (such as accelerator pedal position and engine speed). From these inputs, the ECM determines when to enable the engine exhaust brake feature when the proper braking conditions are present. Other features/switches like cruise control, can also affect when the engine exhaust brake activates. For more information on how the engine exhaust brake functions, refer to the equipment manufacturer service information or contact a Cummins® Authorized Repair Location.

i NOTE

The exhaust brake can only be activated when the accelerator pedal is at its low idle position. With the throttle at low idle position, fueling commands to the cylinders will **not** detract from the braking power of the brake system.

i NOTE

The engine exhaust brake is designed to assist the vehicle service brakes when slowing the vehicle to a stop.

Service brakes will be required to bring the vehicle to a stop.
Vehicle service brakes **must** be used when additional braking power is required.

▲ CAUTION

Never exceed governed engine speed because engine damage can occur. Operating the engine beyond the governed speed causes additional strain on valve train and internal engine com-

ponents. Operate the engine within governed engine speed.

The optimum braking power of the engine exhaust brake is reached at rated engine speed. Correct gear selection, therefore, is critical.

▲ CAUTION

Exceeding governed engine speed can cause engine damage. Operating the engine beyond the maximum engine speed may cause serious engine damage and is considered engine abuse. Use the engine and vehicle braking systems to control engine speed.

i NOTE

Typically, on vehicles equipped with automatic transmissions, the ECM and the transmission will determine the correct gear selection. Refer to the equipment manufacturer service information for additional detail.

Driving

Correct care of your engine will result in longer life, better performance, and more economical operation.

Follow the daily maintenance checks listed in [Engine Maintenance](#) on page 33.

The new PACCAR engine associated with this manual does not require a “break-in” procedure. This section of the manual provides all of the necessary information required for proper engine operation.

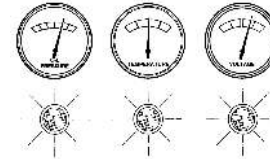

Check the engine oil pressure and engine coolant gauges, warning lamps, and other gauges daily to make sure they are operational. Normally each gauge will make a full sweep when ignition key is

cycled ON to indicate that the gauge is operating correctly.

Generic gauges. Your gauges may differ.

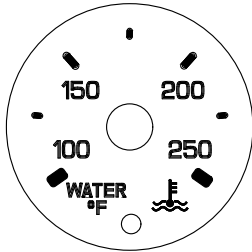
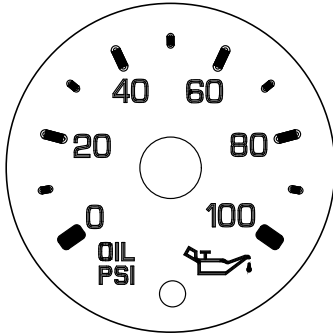

NOTE

If the engine is running, increase engine speed (rpm) or operate the vehicle until the low oil pressure warning lamp turns off.



CAUTION

Engaging the starter motor for more than 30 seconds in any five minute period may cause it to overheat and can damage the starter.

- If starter is engaged continuously for 30 seconds, you must wait five minutes before trying to start the engine to allow the starter motor to cool down.

With the key in the ON position, the engine warning lamps will come on momentarily and then go out. The engine warning lamps include:

Engine Operation Symbols



Check engine lamp; amber in color.



Stop engine lamp; red in color.

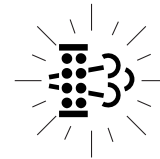

Diesel particulate filter (DPF) status indicator; yellow in color.



Diesel Exhaust Fluid (DEF) indicator;
yellow in color.



High exhaust system temperature (HEST);
amber in color.

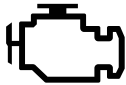

Malfunction Indicator Lamp; amber in color.

Combustible Vapors

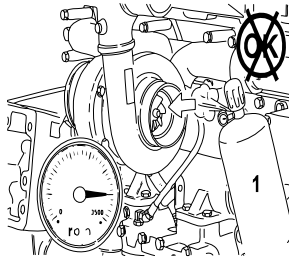

1 DO NOT use combustible gas in turbo



WARNING

Combustible vapors near the air intake system could be ingested into the engine, causing the engine to suddenly accelerate and overspeed. This condition could result in the operator losing control of the vehicle if an unexpected increase in engine rpm occurs. Combustible vapors could also cause a fire. DO NOT operate your vehicle in an area where combustible chemicals or vapors may be present. Failure to

comply may result in death, personal injury, equipment or property damage.



NOTE

Numerous safety devices (i.e. engine shutoff devices) are available to minimize the risk of engine overspeeding caused by combustible vapors being ingested into the air intake system.

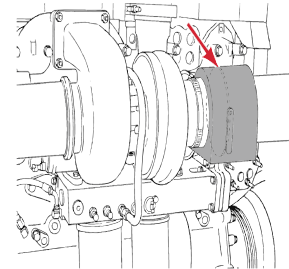

PACCAR recommends the installation of an air intake shutoff device or a similar safety device to minimize the risk of overspeeding, as can occur when the vehicle is being operated in a combustible environment, such as from a fuel spill or gas leak.

**NOTE**

IT IS THE RESPONSIBILITY OF THE OWNER AND OPERATOR TO OPERATE THE VEHICLE IN A SAFE ENVIRONMENT.

Normal Starting Procedure

Allow the **Wait-To-Start** warning lamp to turn off. [Engine Wait-to-Start Light](#) on page 16

Follow this engine starting procedure when the outside temperature is above 50°F (10°C).

1. Ensure the parking brake is set ON and the transmission shift lever is in neutral. For automatic transmissions, be sure the shift lever is in the neutral position (N). For automatic transmissions that have park (P) position, place the shift lever in park.

**NOTE**

If outside temperature is below 50°F (10°C) go to the Cold Weather Starting

Procedure. Start at step 2 and follow the directions until it directs you back to step 2 of this procedure.

2. With the accelerator pedal in the idle position, turn the ignition key to the START position to start the engine.
3. If the engine does not start after 10 seconds, release the key. Wait an additional 10 seconds to allow the starter motor to cool, then try starting the engine again.
4. Once the engine has started, wait for the oil pressure to rise, and the low oil pressure warning lamp to turn off, before increasing rpm.

If the engine does not start, or runs erratically, see Fuel System Priming.

Cold Weather Starting

Allow the **Wait-to-Start** warning lamp to turn off. [Engine Wait-to-Start Light](#) on page 16.

Follow this engine starting procedure when the outside temperature is below 50°F (10°C).

**WARNING**

Using starter fluid to start the engine may result in fire or explosion. Do not use starter fluid. Failure to comply may result in death, personal injury, equipment damage, or property damage.

**CAUTION**

Engaging the starter motor for more than 30 seconds in any 5 minute period may cause it to overheat and can damage the starter motor. If starter is engaged continuously for 30 seconds, you must wait 5 minutes before trying to start the engine. This will allow the starter motor time to cool down.



CAUTION

To reduce the possibility of damage to the lubricating oil pan, due to the materials used in the manufacture of the lubricating oil pan, under no circumstances should an external heat source be applied directly or indirectly to the lubricating oil pan.

1. If you have not already, begin by following the [Normal Starting Procedure](#) on page 21 until it directs you back to step 2 in this cold weather procedure.

Refer to the vehicle operator's manual instructions for any additional cold weather starting procedures.

2. Allow the 12 volt fuel module pre-heater to heat the fuel. Leave the key in the accessory position, without engaging the starter until the Wait-To-Start lamp goes out.



NOTE

Under cold conditions, the Wait-to-Start lamp will also illuminate at key ON, and will stay on for a period of up to 30 seconds. The length of time the Wait-to-Start lamp remains illuminated depends on the ambient temperature. The lower the ambient temperature, the longer the lamp will be illuminated.

During cold weather, the use of winter fuel blends can significantly improve the ease of starting performance, and overall dependability of your vehicle. Winter fuel blends are designed to reduce wax gelling in the fuel filter and lines.

If starting a cold engine, remember to slowly increase the engine speed. This provides adequate lubrication to the bearings and gives ample time to allow the oil pressure to stabilize. Also, for coolant temperatures below 150°F (70°C), use a low gear and drive at moderate engine speed until the engine coolant has reached operating temperature. Do not let the engine idle longer than necessary. If the vehicle cannot be driven, an elevated idle speed may be used instead to warm the engine.

Extreme cold conditions can cause oil pressure delays when using 15W40 viscosity grade engine lubricating oil. For extreme cold conditions, the use of a different engine lubricating oil viscosity is recommended.

Cold weather starting aids are available for this engine. Contact a Cummins® Authorized Repair Location for more information.

3. Return to step 2 in the Normal Starting Procedure



CAUTION

The use of starting aids, such as ether, may result in damage to the engine and engine aftertreatment system.

Starting Procedure After Extended Shutdown or Oil Change

After extended shutdown or an oil change follow the [Normal Starting Procedure](#) on page 21.

The engine will not start until the minimum cranking oil pressure is detected by the ECM. It can take more cranking time to start the engine after an extended shutdown or oil change.

Operating the Engine

Monitor the oil pressure and coolant temperature gauges frequently. Refer to [Engine Oil Capacities and Pressures](#) on page 42 and [Engine Coolant Specifications](#) on page 49 for recommended operating pressures and temperatures. Shut off the engine if any pressure or temperature does NOT meet the specifications.

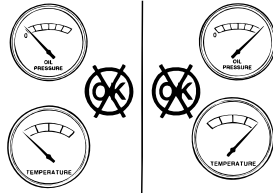

Continuous operation with engine coolant temperature above or below the engine coolant temperature specifications listed in "[Engine Coolant Specifications](#) on page 49" can damage the engine.

Manual Transmission Variable Idle Control



If your truck is equipped with a manual transmission, your engine idle RPM may vary under certain conditions. The engine control module will control the RPM based on various inputs such as vehicle weight, rear axle ratio, road grade and altitude. When starting from a stop, depending on these conditions, the engine RPM may increase to compensate for load in order to ensure a smooth transition into motion.

Engine Operating Range

Proper Engine Operating Range

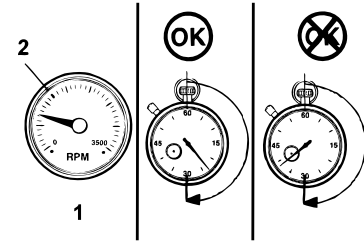

1. Full throttle rpm
2. Peak torque

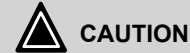

Operating the engine at full throttle below peak torque will shorten engine life to overhaul, can cause serious engine damage, and is considered engine abuse. DO NOT operate the engine at full throttle operation below peak torque rpm for more than 30 seconds. Failure to comply may result in equipment or property damage.

1

PACCAR engines are designed to operate at full throttle under momentary conditions down to peak torque engine speed. This is consistent with recommended operating practices.



CAUTION

Operating the engine beyond the maximum engine speed can cause severe engine damage. Use proper operating techniques for the vehicle to prevent engine overspeed. See Engine Specifications for maximum engine speed. Failure to comply may result in equipment or property damage.

Extended Idling



CAUTION

Prolonged periods of idling can result in lower than optimal engine/transmission operating temperatures, which can cause increased rates of wear. **Do not allow the engine to operate at idle for extended periods at temperatures at or below 160°F (71°C).** To

help prevent this from occurring on PACCAR engines, an idle shutdown feature can be programmed to shut the engine down after a period of low idle operation with no driver activity. A flashing warning light will inform the driver of an impending shutdown. Failure to comply may result in equipment or property damage.



CAUTION

If the truck is equipped with Power Take-off (PTO) equipment, the engine shutdown system can be deactivated when the PTO is operational; however, engine idle periods should not exceed five minutes whenever possible. Failure to comply may result in equipment or property damage.

Long periods of idle time (3 hours or more) may accelerate the build-up of soot in the diesel particulate filter (DPF), especially in cold weather. The system will illuminate the DPF indicator and present a message to indicate that the DPF requires regeneration. Refer to the operator manual for more details.

This is not a problem with the vehicle; however, it indicates that the driver needs to start a parked DPF regeneration to prevent equipment damage caused by soot build up. If the DPF lamp turns ON and the driver is prompted to through driver notifications, perform a parked DPF Regeneration.



CAUTION

Do not ignore the diesel particulate filter (DPF) warning light. The warning light alerts the operator that the DPF should be regenerated. If soot is allowed to fill the DPF and a regeneration is not performed, the DPF will become clogged, requiring it to be removed and cleaned. Failure to comply may result in equipment or property damage.

If an engine must idle for an extended period of time, idle the engine at the lowest rpm that maintains the engine coolant at 150°F (70°C), or above. Following these guidelines will help reduce engine wear during idling and the frequency of DPF regenerations.

Engine Shutdown



CAUTION

Failure to follow the correct shutdown procedure may result in damage to the turbocharger and shorten the turbocharger life.



CAUTION

DO NOT shut off the engine immediately after use, especially after a long trip or if the engine has been subject to high load. The engine is hot and must be cooled. Idle the engine at 1000 rpm for at least 4 minutes, then low idle for an additional 30 seconds before shutting off the engine. Failure to comply may result in engine damage, reducing its service life.

Idle the engine at 1,000 rpm for four minutes. Then low idle for 30 seconds before shutdown. This will allow circulating coolant and lubricating oil to carry heat away from the cylinder head, valves, pistons, cylinder liners, turbocharger, and bearings. This way you can prevent engine

damage that may result from uneven cooling.



NOTE

The ECM and DEF system require battery power supply after key off for a period of up to 10 minutes. The DEF system circulates after a hot shutdown. If the unswitched battery power supply is disconnected less than 10 minutes after the keyswitch is turned off, there may be damage to the DEF system.

Turn the ignition switch to the OFF position. If the engine does **not** shut down, contact your dealer.

Electromagnetic Interference

If not installed correctly, some vehicle accessories (CB radios, mobile transmitters, etc.) can generate radio frequency energy that may cause electromagnetic interference (EMI) between the accessory and the electronically controlled fuel system. Under these conditions, PACCAR is not liable for any performance problems with either the fuel system or the accessory. EMI is not

considered by PACCAR to be an engine failure and therefore is not warrantable.

System EMI Susceptibility

PACCAR products are designed and tested for minimum sensitivity to incoming electromagnetic energy. The fuel system EMI susceptibility has been designed with a high tolerance against EMI and in most normal circumstances, if not all, electromagnetic energy-emitting devices that meet the Federal Communications Commission legal requirements should cause no interference.

System EMI Radiation Levels

Electronic components are required to pass various PACCAR and industry EMI specifications. Our testing has shown that when the engine is properly installed and maintained, it will not interfere with properly installed on-board communication equipment.

If any interference condition is noticed, follow these suggestions to reduce the amount of EMI:

1. Locate the accessory receiving antenna further away.
2. Check with the accessory supplier representative in your area to:

1

- Accurately calibrate the accessory for proper frequency, power output, and sensitivity.
- Determine the optimum antenna location by obtaining antenna reflective energy data measurements.
- Ensure that the optimum antenna type and mounting arrangement is being used.
- Ensure the accessory equipment is properly constructed for maximum filtering to reject incoming electromagnetic noise.

Operating on Level and Dry Pavement



WARNING

DO NOT use the exhaust brake when operating on road surfaces with poor traction (such as wet, icy or snow covered roads). The exhaust brake can cause the wheels to skid on a slippery surface. You could lose control of the vehicle and jackknife if the wheels begin to skid, resulting in an accident. Failure to comply may result in death,

personal injury, equipment or property damage.



WARNING

DO NOT operate the exhaust brake when driving/operating your vehicle bobtail or with a loaded or unloaded trailer on road surfaces with poor traction (wet, icy, or snow covered roads) or in heavy traffic. There may not be enough weight on the rear axle to provide traction. Braking caused by the normal operation of the exhaust brake could cause you to lose control of the vehicle, resulting in an accident. Make sure the exhaust brake is switched "OFF" when driving bobtail or with an unloaded trailer. Failure to comply may result in death, personal injury, equipment, or property damage.

Remove Foot from Accelerator

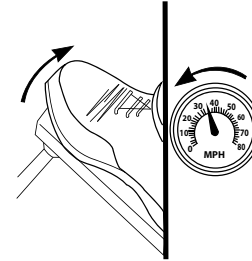

To reduce vehicle speed, put the engine brake or exhaust brake ON/OFF switch in the "ON" position. Remove your foot from the accelerator pedal and clutch pedal. The engine brake or exhaust brake will immediately begin to operate, slowing the vehicle.

For operation on dry and flat surfaces, when greater braking power is not required, put the two-position selector switch in the "LOW" position.

For operation on dry pavement when maximum braking power is required, put

the three-position selector switch in the "Hl" position.

Operating on Grades and Dry Pavement



WARNING

The exhaust brake is not intended as the primary brake for the vehicle, nor is it an emergency brake. The service brakes must be used in an emergency. Relying solely on the exhaust brake to stop the vehicle in an emergency could cause an accident and lead to personal injury. The exhaust brake only helps the service brakes by using pressure to slow the drive train. You must use the service brakes for quick or emergency stops. Failure to comply may result in death, personal injury, equipment or property damage.

"Control speed" is the speed at which the forces pushing a vehicle down a grade are equal to the forces holding it back.

Do Not Exceed Governed Engine Speed

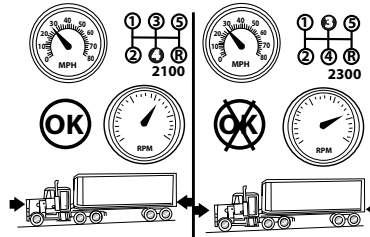

WARNING

DO NOT use the exhaust brake when operating on road surfaces with poor traction (such as wet, icy, or snow covered roads, or gravel). The exhaust brake can cause the wheels to skid on a slippery surface. You could lose control of the vehicle and/or jackknife if the wheels begin to skid, resulting in an accident. Failure to comply may result in death, personal injury, equipment or property damage.



CAUTION

The engine ECM maintains a record of maximum rpm. Exceeding the maximum rpm will be considered driver abuse and will affect the engine warranty. See Engine Specifications. Failure to comply may result in equipment or property damage.



WARNING

DO NOT use an exhaust brake when driving bobtail or with an unloaded trailer. There may not be enough weight on the rear axle to provide traction. This could cause a loss of control and jackknife resulting in an injury accident. Make sure the exhaust brake is switched "OFF" when driving bobtail or with an unloaded trailer. Failure to comply may result in death, personal injury, equipment or property damage.



CAUTION

Never exceed governed engine speed because engine damage can occur. Operating the engine beyond the governed speed causes additional strain on valve train and internal engine components. Operate the engine within governed engine speed.



NOTE

After you have determined what the safe speed is for your vehicle, operate the exhaust brake with the transmission in the lowest gear that will not cause the engine speed to exceed the maximum rated engine speed. The optimum braking power of the exhaust brake is reached at the maximum rated engine speed. Selecting a lower gear will force the engine RPM to increase, along with engine braking efficiency. Start with a higher gear and work downward while observing the engine RPM. Note that the maximum rated engine speed (engine red line)

may NOT be listed on your tachometer.

The engine brake selector switch can be used to vary braking power as road conditions change. Vehicle service brakes must be used when additional braking power is required.

Slow Down Around Curves

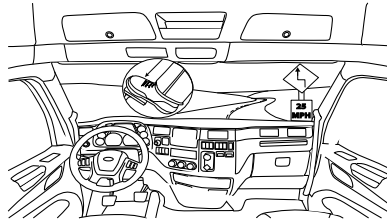

The exhaust brake is **NOT** intended as the primary brake for the vehicle, nor is it an emergency brake. The exhaust brake only helps the service brakes by using pressure to slow the drivetrain. Use the service brakes for quick stops.

Braking Truck on Grade

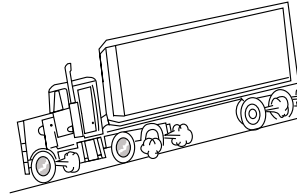

WARNING

DO NOT drive with frequent or continuous use of the service brakes. This can overheat the brakes and result in excessive lining wear, increased stopping distances, possibly an accident and may lead to personal injury. Before descending a steep grade, shift to a lower gear, keep the vehicle speed low, and avoid continuous application to the brakes. Failure to comply may result in death, personal injury, equipment or property damage.

**NOTE**

The longer or steeper the hill, the more important it is to use your exhaust brake. Make maximum use of your exhaust brake by gearing down and letting the exhaust brake do the work.

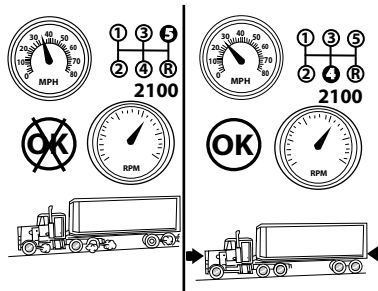
Shift to a Lower Gear on Grade

If frequent use of the vehicle service brakes is required, it is recommended that a slower control speed be used by selecting a lower transmission gear.

Tips for Operation on Slick Roads**WARNING**

To reduce the possibility of personal injury or property damage, always allow for extra distance between your vehicle and other objects when using the service brakes or engine brakes on slick roads. Failure to comply may result in death, personal injury, equipment damage, or property damage.

The operation of any vehicle is difficult to predict on slick roads. The first 10 to 15 minutes of rainfall are the most dangerous, as road dirt and oil mixed with rain create a very slippery surface.

**WARNING**

DO NOT use the vehicle's exhaust brake in any situation that requires an immediate stop and/or in situations of poor traction (such as wet, icy, or snow covered roads). Trying to use the exhaust brake instead of the service brakes may cause a loss of vehicle

control, which may result in an accident involving death or personal injury.

When driving on slick roads, start with the "ON/OFF" switch in the "OFF" position and the two-position selector switch in the "LOW" position. If your tractor is equipped with a twin-screw rear axle, position the power divider switch in the "unlocked" position. Remove your foot from the accelerator pedal to make sure the vehicle will maintain traction with the braking power of the engine alone. If the vehicle drive wheels begin to skid or if there is a fishtailing motion, DO NOT activate the exhaust brake. If traction is maintained using the braking power of the engine alone and more braking power is required, switch the two-position selector switch to the "LOW" position and activate the exhaust brake by switching the "ON/OFF" switch to the "ON" position. If the vehicle's drive wheels begin to skid or there is a fishtailing motion, switch the "ON/OFF" switch to the "OFF" position. If traction is maintained when the exhaust brake is activated and more braking power is required, move the two-position selector switch to the "HI" position. Again, if the vehicle has lost traction or if there is a fishtailing motion, switch the "ON/OFF"

1

switch to the “OFF” position. DO NOT attempt to use the exhaust brake in the “HI” position.

Malfunction Indicator Light (MIL)



This warning light turns on when an engine emissions failure occurs. An emissions failure is not an emergency, and the vehicle can be safely driven, but should be serviced to correct the problem. In some cases, the MIL will activate in conjunction with the High Exhaust System Temperature (HEST), diesel particulate filter (DPF), and Diesel Exhaust Fluid (DEF) warning lights.



NOTE

The Malfunction Indicator Light (MIL) turns on if the on-board diagnostics (OBD) system detects a possible emissions system failure. To ensure the condition is corrected, the vehicle should be brought in for service at the earliest opportunity.

Chapter 2 | ENGINE MAINTENANCE

Maintenance Requirements.....	33
Maintenance Schedule Intervals.....	36
Preventative Maintenance Schedule.....	36
Engine Specifications.....	39
Engine Lubricating Oil Recommendations and Specifications.....	40
Engine Oil Capacities and Pressures.....	42
Engine Lubrication and Filter Intervals.....	43
Cooling System Maintenance.....	47
Engine Coolant Specifications.....	49
Extended Life Coolant.....	50
Fuel Recommendations.....	51
Warranty and the Use of Biodiesel Fuel.....	52
Recommendations to Avoid Fuel Gelling.....	53
Diesel Exhaust Fluid Recommendations and Specifications.....	53
Maintenance Procedures.....	55
Engine Identification.....	72

Maintenance Requirements

Engine Maintenance

PACCAR recommends that the engine be maintained according to the maintenance schedule in this section.

If the engine is operating in ambient temperatures below 0°F (-18°C) or above 100°F (38°C), perform maintenance at shorter intervals. Shorter maintenance intervals are also required if the engine is operated in a dusty environment or if frequent stops are made.

Some of these maintenance procedures require special tools or must be completed by qualified personnel. Contact your local PACCAR authorized repair location for detailed information.

If your engine is equipped with a component or accessory not manufactured by PACCAR Inc, refer to the component manufacturer's maintenance recommendations.



WARNING

Never idle your vehicle for prolonged periods of time if you sense that exhaust fumes are entering the cab. Investigate the cause of the fumes and correct it as soon as possible. If the vehicle must be driven under these conditions, drive only with the windows open. Failure to repair the source of the exhaust fumes may result in death, personal injury, equipment or property damage.



WARNING

Exhaust fumes from the engine contain carbon monoxide, a colorless and odorless gas. DO NOT breathe the engine exhaust gas. A poorly maintained, damaged or corroded exhaust system can allow carbon monoxide to enter the cab. Entry of carbon monoxide into the cab is also possible from other vehicles nearby. Failure to properly maintain your vehicle could cause carbon monoxide to enter the cab, resulting in death or personal injury.

Cleaning the Engine

You must clean the undercarriage, engine compartment, and engine as needed, but at least annually. Cleaning removes road salt and debris that can be corrosive or otherwise harmful to the electrical system. Failure to properly clean the undercarriage of the truck can increase the risk of an electrical fire. When cleaning the engine, follow the instructions from the vehicle manufacturer's operator's manual and observe all environmental protection regulations.



WARNING

Do not direct high pressure water onto electrical components, plug connectors, seals or flexible hoses on the engine. Failure to comply can accelerate corrosion and degrade electrical component which may cause a fire or equipment damage. Failure to comply may result in death, personal injury, equipment damage, or property damage.



CAUTION

Do not direct high pressure water onto seals or flexible hoses. Water may enter the part which will contaminate the system lubricants and fluids. To prevent damage to these components, keep a gentle flow of water moving at all times. Failure to comply may result in equipment damage.

Daily or Refueling Maintenance Checks

Visual Inspection of Engine

This procedure should be followed as part of daily and refueling maintenance checks.

1. Check for any signs of fluid leaks.
2. Ensure all access caps/covers are installed and tight.
3. Excessive oil, coolant or fuel consumption
4. Loose or damaged parts
5. Worn or damaged belts
6. Worn or damaged wiring harnesses
7. Any change in system appearance
8. Odor of fuel
9. Odor of electronic devices.

10. When operating the engine, listen for any unusual system noises which can indicate service is required.

Daily Maintenance Items

Daily maintenance tasks below must be performed to properly maintain the engine:

Fuel Filter / Water Separator on page 34
Coolant Level on page 34
Chassis Fuel Filter / Water Separator on page 34
Engine Oil Level on page 55
Cooling Fan on page 34 and Coolant Level on page 34
Aftertreatment Exhaust Piping on page 35
Air Intake Piping on page 35
How to Drain Moisture from Air Tank on page 35
Diesel Exhaust Fluid on page 35

Fuel Filter / Water Separator

This procedure should be followed as part of daily and refueling maintenance checks.

1. Drain trapped water (if equipped). Refer to the [Fuel Filter Water Draining Procedure](#) on page 60.

Chassis Fuel Filter / Water Separator

This procedure should be followed as part of daily and refueling maintenance checks.

1. Drain trapped water (if equipped).

Cooling Fan

This procedure should be followed as part of daily and refueling maintenance checks.

1. Inspect for cracks.
2. Inspect for clearance to other components.

Coolant Level

Replacement or top up coolant should have the same antifreeze concentration and corrosion inhibitor content as the original coolant in the cooling system. If operating in sub-freezing conditions, a 60/40 mix of antifreeze and distilled water may be substituted.

Always dilute antifreeze to the correct concentration based on freeze protection before adding it to the cooling system. Adding or using 100% antifreeze in a

cooling system may result in cooling system plugging and overheating problems.

This procedure should be followed as part of daily and refueling maintenance checks. Perform the following steps to check the coolant level:

1. Check that vehicle is on a level surface.
2. Ensure engine has not been run for several hours.



CAUTION

Due to thermal expansion the coolant level **CANNOT** be checked if the coolant is above ambient temperature or the engine has not completely cooled. The coolant level indicated on a warmed system will be inaccurate and can lead to low coolant conditions during cold-starts. Failure to comply could result in equipment damage.

3. Check coolant level. It should be visible through the clear plastic surge tank.
4. Add coolant as necessary until proper level is reached; see special fill instruction if filling from empty.



NOTE

The pressure cap (on the rear-top of the surge tank) should **NEVER** be removed. The fill cap (on the ergonomic fill neck, not on the surge tank) is the correct fill point.

Aftertreatment Exhaust Piping

This procedure should be followed as part of daily and refueling maintenance checks.

1. Inspect for cracks.
2. Inspect for clearance to other components (i.e. electrical harnesses, etc.).
3. Inspect hose/pipe condition – deterioration/signs of leaking.

Air Intake Piping

This procedure should be followed as part of daily and refueling maintenance checks.

1. Inspect hose/pipe condition – deterioration/signs of leaking.
2. Inspect hose clamps for tightness and pinching/cutting of hoses.
3. Inspect clearance to other components.
4. Check air restriction gauge.

How to Drain Moisture from Air Tank

1. Locate the various air tanks on the vehicle
2. On the air tank, look for a valve, typically on the bottom of the tank.

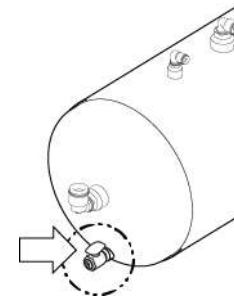

3. To eject moisture from the air system tanks, pull the line that is connected to the moisture ejection valve.
4. Continue pulling until the air comes out free of water.

Diesel Exhaust Fluid

This procedure should be followed as part of daily and refueling maintenance checks.

1. Check level of diesel exhaust fluid.



NOTE

It is recommended to top up DEF when refueling. See Engine Aftertreat-

ment Systems Operator's Manual for DEF information.

Maintenance Schedule Intervals

2

PX-7 Maintenance Intervals

Maintenance Interval	Miles	Kilometers	Hours	Months
A	7,500	12,000	250	3
B	15,000	24,000	500	6
C	15,000	24,000	500	12 (1 year)
D	30,000	48,000	1,000	12 (1 year)
E	60,000	96,000	2,000	N/A
F	75,000	120,000	2,500	N/A
G	150,000	241,500	5,000	48 (4 years)
H	200,000	321,500	6,500	N/A

Preventative Maintenance Schedule

The following list provides recommended maintenance tasks and intervals that

should be performed for PACCAR PX series engines. Perform maintenance at whichever interval occurs first. At Maintenance Schedule Intervals, perform all previous maintenance checks that are due for scheduled maintenance.

i NOTE
 When using Biodiesel of any description, reduce the maintenance interval time found in the following schedules by one half (50%).

i NOTE
 This maintenance schedule is for a normal duty cycle engine operation. Severe duty/vocational applications will need to adjust mileage, kilometer, hour, or time interval based on the Engine Lubrication and Filter Intervals.

i NOTE
 Due to the design of the crankcase ventilation module, routine service of this component is not required.

PX-7 Preventative Maintenance Schedule

Component ¹	Maintenance Task	Recommended Preventative Maintenance Interval							
		A	B	C	D	E	F	G	H
Emissions Components	Diesel Particulate Filter (DPF) - Clean								•
	Diesel Exhaust Fluid (DEF) Filter Access on page 69 - Replace								•
	Exhaust System - Check for Leaks	•							
	Exhaust System - Replace Flex Pipe(s)						•		
Air System & Compressor	Air Compressor on page 70 - Check					•			
	Air Compressor Hoses				•				
	Air Cleaner on page 71	•							

Component ¹	Maintenance Task	Recommended Preventative Maintenance Interval							
		A	B	C	D	E	F	G	H
Charge Air System	Charge Air Piping on page 71	•							
	Charge Air Cooler on page 71	•							
Charging / Cranking System	Electrical Harness / Cables on page 71	•							
	Batteries, Cables, and Connections on page 71		•						
Cooling System	Coolant/Antifreeze Condition on page 65 - Check		•						
	Radiator Hoses Inspection on page 66					•			
	Radiator Pressure Cap - Check		•						
	Change Extended Life Coolant on page 50							•	
Crankshaft	Crankshaft - Vibration Damper on page 72 - Rubber Type Replace					•			
	Crankshaft - Vibration Damper on page 72 - Viscous Type Check					•			
Drive Belts	Engine Belt Checks on page 68			•					
	Fan Belt Tensioner (If So Equipped) on page 68			•					

Component ¹	Maintenance Task	Recommended Preventative Maintenance Interval							
		A	B	C	D	E	F	G	H
Engine Lubrication	Replace oil and filter	<i>Engine Lubrication and Filter Intervals</i> on page 43							
Mounting Bolts	<i>Engine Mounting Bolts</i> on page 72			•					
Overhead Set (Valves)	Adjust							•	
Engine Steam Clean	Check					•			
¹ Follow the manufacturers' recommended maintenance procedures for the starter, alternator, batteries, electrical components, exhaust brake, charge-air cooler, radiator, air compressor, air cleaner, refrigerant compressor, and fan clutch.									

Engine Specifications

PACCAR PX-7

Horsepower	See the EPA label on top of the valve cover, towards the rear of the engine.
Firing Order	1-5-3-6-2-4
Crankshaft Rotation (viewed from front of engine)	Clockwise
Displacement	409 CID (6.7 liters)
Bore and Stroke	4.21 in. × 4.88 in. (107 mm × 124 mm)

Approximate dry weight (without standard accessories)		1,151 lb (522 kg)
Idle Speed		Minimum 700 rpm to maximum 900 rpm
Maximum overspeed capability (15 seconds maximum)		4,200 rpm
Minimum ambient temperature for unaided cold start		-10°F (-12.2°C)
Typical engine cranking speed		120 rpm
Overhead adjustment	Intake valve adjustment	0.010 in. (0.254 mm)
	Exhaust valve adjustment	0.026 in. (0.660 mm)

Filter Specifications

PACCAR is not responsible for problems caused by non-genuine filters that do not meet PACCAR performance or durability requirements.

Contact your local PACCAR authorized repair location for specific part numbers. Fleetguard filters are standard on new PACCAR engines. PACCAR recommends their use.

Fleetguard products meet all PACCAR test standards to provide the quality filtration necessary to achieve the engine's design life. PACCAR PX engines are manufactured with Fleetguard filters. If other brands are substituted, the purchaser

should ensure the filter specification meet or exceed the Fleetguard specifications.

	CAUTION
PACCAR approved filters must be used. Failure to comply may cause severe engine damage.	

Engine Lubricating Oil Recommendations and Specifications

A major factor in maintaining engine performance and durability is the proper use of quality engine lubricating oils in conjunction with the appropriate oil drain and filter change intervals. Attempting to extend the oil and filter change interval beyond the manufacturer's recommendations may decrease engine life due to factors such as corrosion, deposits, and wear.

See "Engine Lubrication and Filter Intervals" to determine which oil drain interval to use for an application.

i NOTE

It is the operator's responsibility to follow these recommendations to ensure that the engine warranty is not affected.

The primary PACCAR recommendation is for the use of SAE 10W-30 API CK-4 or CJ-4 multigrade lubricating oil for normal operation at ambient temperatures above 5°F (-15°C). For ambient temperatures below 5°F (-15°C) SAE 5W-40 may be used, provided it meets API CK-4 or CJ-4 oil specifications and biodiesel or biodiesel blended fuel is not used as fuel for the engine. Use of 0W-40 and 0W-30 synthetic oils that meet API CK-4 or CJ-4 certification can be used in operations where the ambient temperature never exceeds 32°F (0°C). 0W-40 and 0W-30 oils do not offer the same level of protection against fuel dilution as do higher multigrade oils. Higher cylinder wear can be experienced when using 0W-40 or 0W-30 oils in high-load situations. Using a

multigrade oil helps improve engine cranking in low-temperature conditions, reduces deposit formation and increases engine durability.

i NOTE

For **severe duty** applications the use of 15W-40 is advised.

⚠ CAUTION

The use of a fuel economy oil such as an API FA-4 oil is not approved for this engine. Failure to comply may result in equipment or property damage.

Oil viscosity must be chosen according to the typical climate conditions experienced by the user. See the accompanying chart.

- **10W-30** is recommended for normal engine operation and provides the best wear protection.
- **15W-40** is compatible for improved engine durability at extremely high ambient temperatures.
- **5W-40** is approved for colder ambient temperatures to improve oil flow during start up.

- **0W-40, 0W-30** synthetic oils that meet CK-4 certification can be used in operations where the ambient temperature **never** exceeds 32°F (0°C). 0W-40 and 0W-30 oils do **not** offer the same level of protection against fuel dilution as do higher multigrade oils. Higher cylinder wear can be experienced when using 0W-40 or 0W-30 oils in high-load situations.

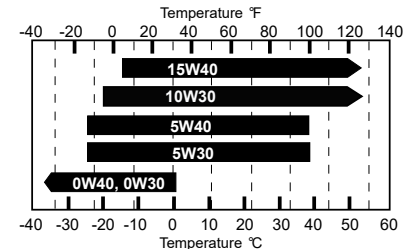

i NOTE

Any of the oil weights listed in the chart above are acceptable to use as long as the oil meets API CK-4 oil specifications.

New Engine Break-in Oils

PACCAR does not approve the use of special “break-in” engine lubricating oils for new or rebuilt PACCAR engines. It is recommended to use the same lubricating oil for engine break-in that will be used during normal operation.



CAUTION

A sulfated ash limit of ≤ 1.0 percent has been placed on all engine lubricating oils recommended for use in PACCAR engines. Higher ash oils can cause valve and/or piston damage and lead to excessive oil consumption. Failure to comply may result in equipment damage.



CAUTION

The use of a synthetic-base oil does not justify extended oil change intervals. Extended oil change intervals can decrease engine life due to factors such as corrosion, deposits, and wear. Failure to comply may result in equipment damage.

Additional information regarding lubricating oil availability throughout the world is available in the EMA Lubricating Oils Data Book for Heavy-duty Automotive and Industrial Engines. The data book can be ordered from: Engine Manufacturers Association, Two North LaSalle Street, Chicago, IL 60602; (312) 827-8733, (www.enginemanufacturers.org).

Aftermarket Oil Additive Usage

PACCAR does not recommend the use of aftermarket oil additives. Today's high-quality engine lubricating oils are very sophisticated. Most oils already contain precise amounts of additives blended into the lubricating oil to meet stringent performance requirements. These oils meet performance characteristics that conform to the lubricant industry standards and are sufficient protection when used according to the recommendations. Aftermarket lubricating oil additives are not necessary to enhance engine oil performance and may in some cases reduce the oil's capability to protect the engine.

Engine Oil Capacities and Pressures

Engine Oil Capacity and Acceptable Pressures

PACCAR PX-7		
Oil Pressure	At low idle (minimum allowable)	10 psi (69 kPa)
	At road speed (minimum allowable)	30 psi (207 kPa)

Oil regulating valve opening pressure range		65-75 psi (448-517 kPa)	
Oil filter differential pressure to open bypass		50 psi (345 kPa)	
Lubricating oil filter capacity		1 qt. (0.950 liters)	
Maximum oil temperature		280°F (138°C)	
Lubricating oil capacity of standard engine (U.S. qts.)	Standard oil pan	Pan only	15 qts. (14.2 liters)
		Total system	17.6 qts. (16.7 liters)
		High to low (on dipstick)	2 qts. (1.9 liters)

Engine Lubrication and Filter Intervals



CAUTION

Extending the oil and filter change interval beyond the recommendations will decrease the engine life due to factors such as corrosion, deposits, and wear. Engine oil filters capture dirt and remove deposits from the oil to prolong the life of internal moving components. Follow the oil and filter change intervals as recommended in

this section of the manual. Failure to comply may result in equipment or property damage.

The lubricating oil and lubricating oil filter interval can be adjusted based on application, fuel consumption, gross vehicle weight, and idle time. Use the following questions to determine the maximum recommended oil change and filter change intervals in kilometers, miles, hours, or months, whichever comes first.

Is the vehicle one of those listed below?

- Delivery truck
- Fire truck or emergency vehicle

If "Yes," select the correct oil drain interval from Table 1. If "No," is the vehicle one of those listed below?

- Refuse truck
- Mixer truck or dump truck

If "Yes," select the correct oil drain interval from Table 2. If "No," is the vehicle one of those listed below?

If the vehicle type is not listed, select the correct oil drain interval from Table 3. Perform maintenance at whichever interval occurs first.



NOTE

If the equipment is using a remote oil tank in which oil is continuously circu-

lated (not an oil make-up tank), the oil in the remote tank must be changed when the oil in the lubricating oil pan is changed.

2

Table 1: Maximum Oil Drain Interval

(A) Severe-Duty (If vehicle meets any of these conditions)	(B) Normal-Duty (If vehicle meets both conditions)
Average fuel economy is less than 7 mpg (2.98 km/liter), or idle time is 40 percent or greater, or vehicle operates in dusty conditions, or gross vehicle weight is greater than 46,000 lb (20,865 kg).	Average fuel economy is greater than 7 mpg (2.98 km/liter) and gross vehicle weight is less than 46,000 lb (20,865 kg).
Vehicle uses the severe-duty oil drain interval (A)	Vehicle uses the normal-duty oil drain interval (B)
If equipped with a 15 qt (14.2 liter) oil pan: 9,000 mi (14,500 km), 500 hours, 12 months, or 2,000 gallons (7,571 liters) of fuel, whichever comes first.	If equipped with a 15 qt (14.2 liter) oil pan: 15,000 mi (24,000 km), 500 hours, 12 months, or 2,000 gallons (7,571 liters) of fuel, whichever comes first.
If equipped with a 19 qt (18 liter) oil pan: 12,000 mi (19,000 km), 550 hours, 12 months, or 2,000 gallons (7,571 liters) of fuel, whichever comes first.	If equipped with an 19 qt (18 liter) oil pan: 20,000 mi (32,000 km), 550 hours, 12 months, or 2,000 gallons (7,571 liters) of fuel, whichever comes first.

Table 2: Oil Drain Interval

	With 15 qt [14.2 liter] oil pan				With 19 qt [18 liter] oil pan			
	Miles	Kilometers	Hours	Months	Miles	Kilometers	Hours	Months
Refuse truck, Mixer or Dump truck								
Below 10 mph average	3,000	4,850	500	12	4,000	6,450	550	12
10 to 15 mph average	6,000	9,650	500	12	8,000	12,500	550	12
15 to 20 mph average	8,500	13,750	500	12	11,000	17,750	550	12
20 to 25 mph average	9,000	14,500	500	12	12,000	19,000	550	12
Above 25 mph average	12,000	19,000	500	12	16,000	25,750	550	12

Table 3: Oil Drain Interval

Vehicle/ Equipment	With 15 qt [14.2 liter] oil pan				With 19 qt [18 liter] oil pan			
	Miles	Kilometers	Hours	Months	Miles	Kilometers	Hours	Months
Truck crane	9,000	14,500	500	12	12,000	19,000	550	12
Yard spotter	9,000	14,500	500	12	12,000	19,000	550	12
All others	9,000	14,500	500	12	12,000	19,000	550	12

- Cummins Inc. bases the oil drain specifications on duty cycle and oil contamination. This contamination occurs in all engines, at varying rates, regardless of the drain interval.
- Maintaining the correct oil and filter change interval is a vital factor in preserving the integrity of an engine. Lubricating oil filters **must** be changed when the oil is changed.



NOTE

If the type/oil capacity of each lubricating oil pan is not known:

- Contact a PACCAR Inc. Authorized Repair Location
- Determine the capacity of the oil pan option for the engine being serviced by using QuickServe™ Online and the engine serial number.
- Fill the lubricating oil pan to the smallest oil pan capacity listed for the engine being serviced.

Then add 1 US qt (0.95 liters) of oil at a time until it reaches the high mark on the dipstick. Record the number of quarts/liters added, so the capacity is known the next time the oil is drained.

- For the latest information for your engine, please refer to Cummins QuickServe™ Online (quickserve.cummins.com) or call 1-800-CUMMINS (1-800-286-6467)

Cooling System Maintenance

The cooling system in your vehicle was factory filled with extended life coolant that meets or exceeds all ASTM D6210 and Caterpillar EC-1 requirements. PACCAR recommends only using a 50/50 mixture of distilled water and ELC when cooling system service is required. A 50/50 mixture of ELC and distilled water will provide freeze protection down to -34°F (-37°C), which is adequate for most locations in North America. For extremely cold operating conditions, a 60/40 mixture (coolant/water ratio) can be used to provide freeze protection down to -62°F (-54°C).

Unless otherwise optioned, factory fill coolant is an ethylene glycol, nitrated organic acid technology (NOAT) extended life coolant (ELC) formulation at a 50:50 coolant-to-distilled water mixture. The factory fill meets or exceeds ASTM D6210 and Cummins Engineering Standard 14603 for ISX and PX engines, and MAT74002 for PACCAR MX-11 and MX-13 engine requirements. Maintaining coolant chemistry and freeze protection is critical to

engine and cooling system component health and longevity.



WARNING

Coolant is toxic. DO NOT get the fluid in eyes. If contact occurs, flood eyes with large amounts of water for 15 minutes. Avoid prolonged or repeated contact with skin. In case of contact, immediately wash skin with soap and water. DO NOT ingest coolant. If swallowed, seek immediate medical attention. DO NOT induce vomiting. Failure to comply may result in death, personal injury, equipment or property damage.



CAUTION

The engine cooling system has very specific maintenance and inspection requirements. Failure to follow requirements can damage the engine. Engine damage can include but is not limited to freezing, boiling, corrosion, pitted cylinder liners. This information is found in the engine manufacturers owner's manual. It is the owner's re-

sponsibility to follow all requirements listed in the engine manufacturers owner's manual. Failure to comply may result in engine damage.



NOTE

Coolant is harmful to the environment. Unused coolant must be stored as a toxic hazardous material in leakproof containers. Used coolant must be processed as industrial chemical waste. Please follow HAZMAT guidelines with both used and unused coolants.

Concentration

Check the level of freeze/boilover protection, which is determined by the glycol concentration. Use a glycol refractometer to determine glycol level. Add coolant to obtain the coolant/water ratio required to provide the protection you need. A 50/50 mix of coolant and water is adequate for most applications. For extremely cold operating conditions, the ratio can be adjusted to a higher concentration of coolant.



NOTE

Maximum recommended ELC concentration is 60% ELC and 40% water by volume (a 60:40 coolant mixture). The minimum recommended concentration is 40%.

Condition

Perform a visual inspection of the coolant. It should have no cloudiness or floating debris. Determine the chemical inhibitor concentration level by using an extended life coolant specific test kit or test strips. Inhibitor concentration level determines corrosion protection. If you are concerned about possible coolant quality, contamination, or mechanical problems, submit a coolant sample for analysis. Improper maintenance may cause coolant degradation and could result in damage to the cooling system and engine components. Consult your dealer or the coolant manufacturer's representative for recommended extended life coolant test kits, test strips, and laboratory sample procedures.

High-quality water is important for cooling system performance. Excessive levels of calcium and magnesium contribute to scaling problems, and excessive levels of chlorides and sulfates cause cooling system corrosion. Water used to prepare coolant from concentrate must meet the requirements listed in the table below.

Water Quality	
Calcium Magnesium (hardness)	Maximum 170 ppm as (CaCO ₃ + MgCO ₃)
pH	5.5 to 9.9 (min/ max)
Chloride	40 ppm as (Cl)
Sulfur	100 ppm as (SO ₄)

Glycol Concentration Level

Level	Desired Coolant / Water Ratio	Freeze Point °F (°C)
Recommended Levels	40%	-12 (-24)
	45%	-23 (-31)
	50%	-34 (-37)
	55%	-50 (-46)
	60%	-62 (-54)

Coolant Extender

Add extended life coolant extender, if necessary, according to the corrosion inhibitor concentration required. DO NOT add coolant extender to nitrite-free coolant.

Checking Coolant Level

Check the coolant level daily. See [Coolant Level](#) on page 34.

**CAUTION**

When adding coolant, avoid mixing different brands and formulations. If the coolant is mixed with more than 25% of a different formulation (for example, mixing OAT and NOAT coolants), engine corrosion damage could occur. If mixing exceeds 25% of total system volume, it is recommended to flush and refill the system completely with one type of coolant.

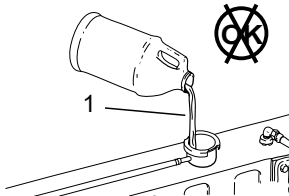
Cooling System Sealing Additives and Soluble Oils

1. Do not use soluble oils or sealing additives.

**CAUTION**

The use of sealing additives or soluble oils in the cooling system can cause damage to the engine. These additives can plug various areas of the radiator, EGR system and oil cooler. The plugging of the cooling system can hamper heat transfer, causing internal engine damage. DO NOT use sealing additives or soluble oils in the cooling system. The use of sealing additives can

- Build up in coolant low-flow areas
- Plug the radiator and oil cooler
- Damage the water pump seal
- Damage heat transfer surfaces
- Damage seals and hoses
- Corrode brass and copper

Failure to comply may result in equipment or property damage.

Engine Coolant Specifications**Engine Coolant Specifications for PACCAR PX-7**

Coolant Capacity (engine only)	3.0 gal (11.5 liters)
Standard modulating thermostat range	186-207°F (86-97°C)
Minimum recommended pressure cap	15 psi (103 kPa)
Maximum recommended pressure cap	25 psi (172 kPa)
Minimum recommended operating temperature	160°F (71°C)

Maximum allowed operating temperature 225°F (107°C)



NOTE

Coolant volumes are dependent on chassis model and cab/sleeper heater options.

Extended Life Coolant

Perform these maintenance procedures according to the Preventative Maintenance Schedule.

- Conduct coolant maintenance checks including freeze point, pH, nitrite and carboxylate tests at least twice annually to maintain engine protection.

Nitrited Extended Life Coolant

For nitrited formulations (NOAT), a heavy-duty extended life coolant that meets ASTM D6210, Cummins Engineering Standard 14603 for ISX and PX engines

and MAT74002 for PACCAR MX-11 and MX-13 engines, must be used. Unless otherwise optioned, factory fill coolant is an ethylene glycol, nitrited organic acid technology (NOAT) extended life coolant (ELC) formulation at a 50:50 coolant-to-distilled water mixture. The factory fill meets or exceeds ASTM D6210 and Cummins Engineering Standard 14603 for ISX and PX engines, and MAT74002 for PACCAR MX-11 and MX-13 engine requirements. Maintaining coolant chemistry and freeze protection is critical to engine and cooling system component health and longevity.

The change interval for extended-life coolant containing nitrite and molybdate is 750,000 miles (1,200,000 km) or 12,000 hours of on-road use (8 years or 15,000 hours of off-highway use) on initial fill with no extender added. The change interval is 1,000,000 miles (1,600,000 km)/20,000 hours/8 years with an extender addition at 500,000 miles (800,000 km)/10,000 hours/4 years.

Nitrite-Free Extended Life Coolant

Nitrite-free organic acid technology coolant (OAT) may be used if it meets DAF 74002. The change interval for nitrite free coolant is 600,000 miles (1,000,000 km) or 6

years, with no extender needed. DO NOT add coolant extender to nitrite-free coolant. Follow the coolant supplier's drain/flush/fill/diluting percentages when servicing a vehicle filled with nitrite-free coolant.

Additional Recommendations:

- Antifreeze is essential for freeze, overheat, and corrosion protection. The use of supplemental coolant additives (SCAs) is not recommended for extended-life coolants.

Recommended Extended Life Coolant Suppliers

Authorized PACCAR Engine dealer



Fuel Recommendations



WARNING

The use of diesel fuel that has been mixed with other fuels may cause an explosion. DO NOT mix gasoline, alcohol, or gasohol with diesel fuel. Make sure you know your fuel source and use the recommended diesel fuel as indicated in this section of the manual. Failure to comply may result in death, personal injury, equipment or property damage.



CAUTION

Dirt or water in the fuel system can cause severe damage to both the fuel pump and the fuel injectors. Due to the precise tolerances of diesel injection systems, it is extremely important that the fuel be kept clean and free of dirt or water. Know your fuel source and make sure all steps are taken for dispensing or using clean fuel in your ve-

hicle. Failure to comply may result in equipment or property damage.



CAUTION

Unapproved fuel can reduce economy or possibly damage fuel system components. Unapproved fuels typically do not have enough lubricity elements in the fuel to properly lubricate the fuel injection system. Be sure you follow the fuel recommendations as indicated in this section of the manual. Failure to comply may result in equipment or property damage.



CAUTION

Using diesel fuels blended with lubricants may cause damage to your engine aftertreatment system. Service intervals for engine aftertreatment systems will be reduced. DO NOT use diesel fuel blended with lubricating oil in engines equipped with an engine aftertreatment system. Failure to comply

may result in equipment or property damage.



CAUTION

DO NOT use high-sulfur diesel fuel as it will damage the exhaust aftertreatment system. Also, the engine will not meet emission regulations. Use only ultra-low-sulfur diesel (ULSD) fuel. Failure to comply may result in equipment or property damage.



CAUTION

If ultra-low-sulfur diesel (ULSD) fuel is not used, the engine may not meet emission regulations, and damage may occur to the engine aftertreatment system. The use of high-sulfur diesel fuel will damage the engine aftertreatment system and impact the engine emission. ULSD fuel is required for correct operation of the aftertreatment. The engine has been optimized for use with an engine aftertreatment system together with ULSD fuel to meet the 2013 U.S. Environmental Protection Agency regulations and the California Air Resources Board. Failure to comply may result in equipment or property damage.



NOTE

PACCAR recommends that the cetane number of diesel fuel be a minimum of 45 for engines that are expected to operate at temperatures below 32°F (0°C) and a minimum of 42 for engines

that are operated at temperatures above 32°F (0°C).

Using diesel fuel with a lower-than-recommended cetane number can cause hard starting instability, and excessive white smoke. To maintain satisfactory operation at low ambient temperatures, it is important to specify diesel fuel of the correct cetane number.

PACCAR requires all permissible fuels to have adequate fuel lubricity. Lubricity can be determined by ASTM, specification D6079, ISO 12156, High Frequency Reciprocating Rig (HFRR) in which the fuel must have a wear scar diameter of 0.02 in. (0.5 mm) or less.

The use of Ultra-low-sulfur diesel (ULSD) fuel is required for this engine in order to meet emission regulations and to prevent damage to the engine and exhaust system. The use of other grades of diesel fuels other than ULSD fuel will be considered a use of incorrect fuel for the engine.

PACCAR is not responsible for failures caused by the use of incorrect fuel, oil or DEF or by water, dirt or other contaminants in the fuel or DEF.

Warranty and the Use of Biodiesel Fuel

PACCAR Inc. approves the use of biodiesel fuel blends up to 20 percent by volume in diesel fuel providing that the following conditions are met:

- The biodiesel used in the blend meets ASTM Standard D6751 or EN 14214 specifications.
- The biodiesel used in the blend is sourced from a BQ-9000 Accredited Producer.
- The finished blend meets the fuel properties of the ASTM Standard D975 (up to B5 blend) or D7467 (B6 to B20 blend).
- If using B6-B20 the engine oil and oil filter are changed per the modified schedule. See the Preventative Maintenance Schedule.
- If using B6-B20 the fuel filter is changed every 25,000 miles (40,000 km).

The use of approved biodiesel fuel does not affect the PACCAR engine warranty. Failures caused by the use of non-

approved biodiesel fuels or other fuel additives that are of unacceptable quality or do not meet specified industry standards are not considered as defects of parts or workmanship by PACCAR and therefore will not be covered by the PACCAR engine warranty.

PACCAR recommends that customers intending to use biodiesel blends become familiar with the additional handling considerations of these fuels such as aging, metal compatibility and tendency to absorb water. Please reference the fuel supplier's technical information or industry guidelines such as the American Trucking Association Truck Maintenance Council document RP 357.

In particular, operators should be aware that biodiesel blends are more prone to cold flow (gelling) and filter plugging issues compared to conventional diesel fuel. If vehicles are expected to be operated in temperatures below freezing, care should be taken to ensure that both the biodiesel fuel used and the appropriate vehicle fuel system accessory heaters are utilized. Operators should also be aware that biodiesel energy content (by volume) is lower than diesel which can reduce fuel economy by up to two percent.

Recommendations to Avoid Fuel Gelling

To avoid fuel gelling in cold weather:

- Use appropriate fuel grade/blend for conditions
- Spec your vehicle with proper cold weather equipment (12V electric pre-heater, fuel/coolant heater, 12V fuel line heaters and fuel tank heaters)

PACCAR does not recommend the use of fuel additives, however, if a customer needs a winter fuel additive, PACCAR offers the following guidance;

- Use an industry known, high quality product (EPA-approved)
- Check the product label to ensure it is compatible with ultra-low sulfur diesel fuel and aftertreatment systems
- Only use the additive for the minimum time needed
- Follow the additive manufacturer's instructions exactly

Diesel Exhaust Fluid Recommendations and Specifications



CAUTION

It is unlawful to use diesel exhaust fluid (DEF) that does not meet the specifications provided or to operate the vehicle/equipment without DEF. Failure to comply may result in equipment or property damage.



WARNING

Diesel Exhaust Fluid (DEF) contains urea. DO NOT get the substance in your eyes. In case of contact, immediately flush eyes with large amounts of water for a minimum of 15 minutes. DO NOT ingest DEF. In the event the diesel exhaust fluid is ingested, contact a physician immediately. Reference the Materials Safety Data Sheet (MSDS) for additional information. Failure to comply may result in personal injury.



CAUTION

Never attempt to create Diesel Exhaust Fluid (DEF) by mixing agricultural grade urea with water. Agricultural grade urea does not meet the necessary specifications required and the engine aftertreatment system may be damaged. Failure to comply may result in equipment damage.



CAUTION

PACCAR Inc requires the use of DEF meeting ISO 22241-1 (DIN 70070) specifications. There is NO acceptable substitute. Failure to use the correct DEF may cause engine damage and/or void the warranty.

- Some locations may reference the DIN 70070 standard. DEF specification limits of this standard are identical to ISO 22241-1.

PACCAR Inc is not responsible for failures or damage resulting from what PACCAR Inc determines to be abuse or neglect, including but not limited to: operation without correctly specified DEF; lack of maintenance of the engine aftertreatment system; improper storage, or shutdown practices; unauthorized modifications of the engine and engine aftertreatment system. PACCAR is also not responsible for failures caused by incorrect DEF or by water, dirt or other contaminants in the DEF. Refer to your engine and vehicle operator's manuals for maintenance, storage, and shutdown information.

For engines using SCR operating in the United States and Canada, it is recommended that the DEF used be certified by the American Petroleum Institute (API).



NOTE

To ensure the correct DEF is used, PACCAR Inc recommends the use of TRP® CleanBlue Diesel Exhaust Fluid which is available in different quantity options from small to bulk containers.



DEF Availability

- DEF is readily available at truck stops and at all PACCAR Engine

dealers. For assistance locating DEF, contact your local PACCAR authorized repair location.

- If your vehicle is out of DEF and you are unable to locate a source to purchase DEF, please contact the vehicle OEM customer care center at the telephone number provided in the vehicle operator's manual. The vehicle OEM customer care center will be able to contact the nearest dealer location to you and arrange for an emergency shipment of DEF to your location 24 hours a day.
- AUS 32 (Aqueous Urea Solution 32)
- AdBlue
- NOx Reduction Agent
- Catalyst Solution

Regardless of what the DEF is called, the DEF must meet the ISO 22241-1 (DIN 70070) specifications. The following are other common names used for Diesel Exhaust Fluid (DEF):

Maintenance Procedures

Engine Oil Level

To check engine oil level, park vehicle on level ground and wait 15 minutes after shutting off engine. After the engine is shut off it will take at least 15 minutes for all the engine oil to return to the sump.



NOTE

It takes approximately 15 minutes for all the oil to run into the sump when the engine is 'warm.' If the level is checked immediately after switching off the engine, the dipstick will show a low oil level.

Make sure that the vehicle suspension is sitting flat, both lengthwise and crosswise. Check this carefully on a vehicle with air suspension.

Engine coolant should be at or above the operating temperature of 180°F (82°C). This procedure should be followed as part of routine maintenance checks.

1. Twist the dipstick handle to unlock it, then pull the dipstick out of the holder.
2. Wipe the dipstick clean with a lint-free cloth.
3. Reinsert the dipstick into the holder.
4. Remove the dipstick from the holder and check the oil level. The oil level should always be between the two marks on the dipstick.
5. Reinstall the dipstick and twist to lock it in place.

Oil Level Indication on Dipstick



NOTE

On the engine oil dipstick, the difference between the low oil level mark (2) and high oil level mark (1) is two US quarts (1.9 liters).

Engine Oil Dip Stick Markings

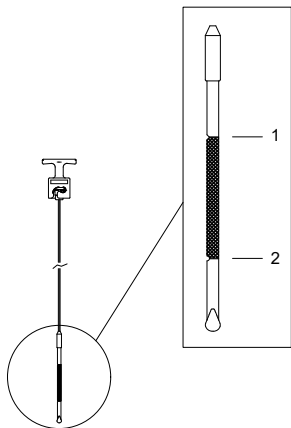

1. High oil level (1)
2. Low oil level (2)

Topping Up the Engine Oil

If checking the engine oil just after stopping the engine, wait 15 minutes for the oil to drain back into the oil pan before checking the fluid level.

This procedure should be followed when oil level is low and more oil needs to be added.

1. Top up with oil, if necessary, via the filler opening. Use the correct grade in the correct quantity.
2. After topping up, wait one minute and check the oil level again.
3. Reinstall the oil fill cap and twist to lock it in place.

Engine Oil Filter

Always use quality engine lubricating oils in conjunction with the appropriate oil drain and filter change intervals. Refer to the for the recommended oil and filter change service interval.



CAUTION

Use of non-genuine PACCAR oil filters can cause severe engine damage.

Oil Filter Removal Preparation



CAUTION

The oil change process must be completed, the engine restarted, and idled for five minutes before beginning the fuel filter change process. Failure to comply could result in a non-warrantable engine failure.



CAUTION

Before beginning to remove and/or disconnect any components, wait at least 5 minutes after the key switch is turned OFF for the aftertreatment DEF dosing system to purge the DEF from the system. The DEF system purges to prevent damage from freezing. Failure to comply may result in equipment or property damage.

**WARNING**

Turn off the engine and place the ignition switch in the OFF position before disconnecting the battery clamps. DO NOT place any tools or other materials on top of or close to the batteries. This can cause a dangerous high current short circuit and, in the worst case, a battery explosion. Keep all objects away from the battery terminals. Always break the contact between the battery clamp and the negative terminal before working on the vehicle. Working on a vehicle while the battery is connected may result in electrical injury or damage. Always disconnect the battery at the negative terminal when performing service procedures. Failure to comply may result in death, personal injury or equipment damage.

**WARNING**

Electrical shock hazard: Never disconnect the battery clamp when the engine is running. Disconnecting the battery clamps while the engine is running

may result in death, personal injury or equipment damage from electrical arcing or damage to electrical components.

1. Disconnect the chassis battery cable at the negative battery terminal.
2. Place an oil collection pan directly under the oil filter.

Oil Filter Removal**WARNING**

Lubricating oil can cause skin irritation or skin injury. To prevent skin injury, avoid unnecessary contact with the lubricating oil. Wear protective clothing, eye wear, and gloves when handling lubricating oil. Failure to comply may result in personal injury.

**CAUTION**

DO NOT replace the engine oil filter and fuel filters at the same time. Doing

so may lead to a "dry start" condition where the engine starts before adequate oil pressure has reached all engine components, leading to extreme engine damage. Always remove and replace one filter at a time before moving on to the next.

Recommended Tools:

- Oil filter wrench, Cummins part number 3400158
- Drain pan capable of holding 21 qt. (20 L)

Follow the procedure below after reading "Oil Filter Removal Preparation."

1. Operate the engine until the water temperature reaches 60°C [140°F).
2. Shut off the engine.
3. Remove the oil drain plug. Drain the oil immediately to be sure all the oil and suspended contaminants are removed from the engine.
4. Clean the area around the lubricating oil filter head.
5. Use an oil filter wrench to remove the filter.
6. Clean the gasket surface of the filter head.



NOTE

The O-ring can stick on the filter head. Verify it is removed before installing the new filter.

2

Oil Filter Installation

Use the following procedure to install oil filters.

1. Use clean engine oil to coat the gasket surface of the filter.
2. Fill the filter with clean engine oil.
3. Apply a light film of lubricating oil to the gasket sealing surface before installing the filter.
4. Install the filter on the oil filter head. Tighten the filter until the gasket contacts the filter head surface.
5. Tighten the filter ¾ to 1 turn after the gasket makes contact with the filter head.
6. Clean and check the lubricating oil drain plug threads and sealing surface. Use a new sealing washer, if damaged.
7. Install the lubricating oil pan drain plug.

Pan type / drain plug size	lb-ft	N-m
Steel / M18	44	60
Steel / M22	59	80
Cast Aluminum / M22	44	60

8. Fill the engine with clean lubricating oil to the proper level. Refer to [Engine Lubricating Oil Recommendations and Specifications](#) on page 40 for oil specifications.



NOTE

Total system capacity assumes lubricating oil pan plus lubricating oil filter.

Some applications use a slightly different lubricating oil pan capacity, and all lubricating oil quantities must be adjusted accordingly. Contact a local Cummins® distributor if there are any questions.



NOTE

If the oil capacity of the oil pan is not known, fill the oil pan to the smallest oil pan capacity. Then add 1 quart of oil at a time until it reaches the high mark on the dipstick. Record the number of quarts added so that capacity is known the next time the oil is drained.

9. Reconnect the chassis battery cable at the negative battery terminal. See "Oil Filter Removal Preparation."
10. Idle the engine to inspect for leaks at the oil drain plug and the oil filter seal.



CAUTION

Increasing the engine speed directly after maintenance or repairs to the lubrication system may cause damage to various engine components.

**CAUTION**

The red oil pressure warning in the instrument panel should disappear within ten seconds of the engine starting. If not, shut the engine OFF and investigate the problem. Failure to do so may cause damage to various engine components.

**CAUTION**

Engine oil pressure must be indicated on the gauge within 15 seconds after starting. If oil pressure is not registered within 15 seconds, shut off the engine immediately to avoid engine damage. Confirm that the correct oil level is in the oil pan.

11. Shut off the engine. Wait approximately 5 minutes to let the oil drain from the upper parts of the engine. Check the level again.
12. Add oil as necessary to bring the oil level to the H (high) mark on the dipstick.
13. Remove oil collection pan and dispose of any spillage properly.

Fuel Filter

Perform these maintenance procedures when indicated by the Preventative Maintenance Schedule.

**WARNING**

When removing the fuel filter, a quantity of fuel will escape. DO NOT smoke or allow an open flame in close proximity. Failure to do so could ignite a fire or cause an explosion which could result in serious injury to you and/or bystanders. Failure to comply may result in death, personal injury, equipment or property damage.

**CAUTION**

Replace fuel filters with parts of the same part number. PACCAR periodically changes its filter design, and filters of different part numbers are not interchangeable. Use of incorrect filter part numbers or non-genuine filters can result in low pressure fuel fault codes and/or severe engine damage. Contact a Kenworth or Peterbilt dealer

to verify the correct fuel filter part numbers.

**NOTE**

The fuel filter and the hand pump are located on the left-hand side of the engine, as viewed from the driver's seat.

**NOTE**

Use of poor quality fuel may require more frequent fuel filter element service.

Description

The fuel filter/water separator module provides fine-particle filtration, water separation, water-in-fuel sensing, 12V preheating and system manual priming in a singular easy to service module. Replace the suction side and the pressure side fuel filters at the same time. It is recommended to replace the fuel filters at the same interval as the oil and oil filter are changed. If the oil drain interval being used is greater than 15,000 mi (24,000 km), as determined by the Engine Lubrication and

Filter intervals, the fuel filter change can be extended until the oil drain interval.

Biodiesel

For information on alternative fuels, such as biodiesel, and additional information for fuel recommendations and specifications refer to "Fuels for Cummins® Engines," Bulletin 3379001. Contact a PACCAR or Cummins authorized service facility for additional information.

For information on alternative fuels, such as biodiesel, and additional information for fuel recommendations and specifications, see [Warranty and the Use of Biodiesel Fuel](#) on page 52.

Fuel Filter Water Draining Procedure

Wear fuel-safe gloves. Have a one liter or larger jar or can available, and a place to responsibly dispose of contaminated water. Follow the steps below to drain water from your primary fuel filter housing.

1. Locate the drain spigot on the bottom of the fuel-filter housing. It is a hand operated butterfly valve. The valve is plastic, and misuse with a tool can damage it.



NOTE

If desired, a ¼ in. (6 mm) hose can be placed over the opening of the drain-spigot which has a provision for hose attachment. This can aid in placing the catch-vessel in a more convenient location.

2. Place a can, or preferably, a transparent jar, below the drain or hose to catch the fuel/water.



CAUTION

Always catch the fuel or water in a container. If a container is NOT used to catch the fuel or water, the fluid can fall directly onto the starter motor, and eventually, the ground. Failure to comply may result in equipment failure and/or cause an environmental hazard.

3. While watching the drain or hose end, open the drain-spigot until fluid starts to drain (about four turns).
4. When no water can be seen in the exiting fuel, close the drain.

5. Discard of the waste fuel/water appropriately.

Fuel filter removal preparation

Read through the entire procedure, including fuel filter removal, fuel filter installation, and fuel system priming before you start to replace the fuel filter. If you do not have all of the needed tools or are not comfortable performing any of the procedures, please take your vehicle to an authorized service facility.



CAUTION

Before beginning to remove and/or disconnect any components, wait at least 5 minutes after the key switch is turned OFF for the aftertreatment DEF dosing system to purge the DEF from the system. The DEF system purges to prevent damage from freezing. Failure to comply may result in equipment or property damage.

**WARNING**

Turn off the engine and place the ignition switch in the OFF position before disconnecting the battery clamps. DO NOT place any tools or other materials on top of or close to the batteries. This can cause a dangerous high current short circuit and, in the worst case, a battery explosion. Keep all objects away from the battery terminals. Always break the contact between the battery clamp and the negative terminal before working on the vehicle. Working on a vehicle while the battery is connected may result in electrical injury or damage. Always disconnect the battery at the negative terminal when performing service procedures. Failure to comply may result in death, personal injury or equipment damage.

**WARNING**

Electrical shock hazard: Never disconnect the battery clamp when the engine is running. Disconnecting the battery clamps while the engine is running

may result in death, personal injury or equipment damage from electrical arcing or damage to electrical components.

1. Disconnect the chassis battery cable at the negative battery terminal.

Fuel Filter Removal

Follow the steps below to remove the fuel filter:

**CAUTION**

DO NOT replace the engine oil filter and fuel filters at the same time. Doing so may lead to a "dry start" condition where the engine starts before adequate oil pressure has reached all engine components, leading to extreme engine damage. Always remove and replace one filter at a time before moving on to the next.

1. Follow the procedure below after reading [Fuel filter removal preparation](#) on page 60.

2. Loosen the fuel tank cap to relieve any pressure in the fuel tank.

**NOTE**

Depending on the vehicle's fuel system configuration, the fuel filter housing may not completely drain of fuel. If this is the case, take care when installing the new filter as this may cause fuel to spill from the filter housing.

3. Clean the fuel filter cap and surrounding area to ensure dirt does not fall into the fuel module.

**CAUTION**

Dirt in the fuel system can lead to significant damage to the fuel system. Failure to comply may result in equipment or property damage.

4. If required, disconnect the wiring harness from the water in fuel sensor.
5. Loosen and remove the fuel filter carefully. Use a strap wrench towards the top of the fuel filter to remove the canister.

6. Make sure the O-ring does not stick to the fuel filter head. Remove the O-ring using an O-ring pick if necessary.



NOTE

The fuel filter cartridge is a disposable filter and must not be cleaned and reused. Dispose of the filter as chemical waste.

Fuel Filter Installation

Follow the steps below to install a new fuel filter:

1. If clean fuel is available, pre-fill new filters, both pressure-side and suction-side with clean fuel prior to installation using the clean side block-off plug packed with the filter. Add the fuel to the outer area of the filter. Do not pour fuel directly into the center of the filter because this will allow unfiltered fuel to enter the system and possibly cause damage to fuel system components.
2. Lubricate the sealing O-Ring that is supplied with the primary fuel filter with clean lubricating oil.

3. Install the filter on the fuel filter head by hand until it is tight.



CAUTION

Mechanical overtightening can distort the threads as well as damage the filter element seal or filter can.

4. Use a strap wrench to tighten the fuel filter another ¼ of a turn.
5. If required, connect the wiring harness to the water in fuel sensor.
6. Connect the batteries.



WARNING

Batteries can emit explosive gases. To reduce the possibility of personal injury, always ventilate the compartment before servicing the batteries. To reduce the possibility of arcing, remove the negative (-) battery cable first and attach the negative (-) battery cable last.

Fuel System Priming



WARNING

The fuel pump, high-pressure fuel lines, and fuel rail contain very high-pressure fuel. To reduce the possibility of personal injury, never loosen any fittings while the engine is running.



CAUTION

Engaging the starter motor for more than 30 seconds in any 5 minute period may cause it to overheat and can damage the starter motor. If starter is engaged continuously for 30 seconds, you must wait 5 minutes before trying to start the engine. This will allow the starter motor time to cool down.



NOTE

Some vehicles are equipped with an engine starting motor protection feature. If the starting motor is engaged for 30 or more seconds, without the engine starting, the starting motor will be locked out from operating, allowing for proper cooling of the starting motor. During this time, the WAIT TO START lamp, if equipped, will flash for 2 minutes. Once the lamp discontinues flashing, the starting motor will be allowed to function.



NOTE

The priming pump can be an OEM-supplied component and can be designed or installed differently. If a priming pump is not installed or is a different design, refer to the OEM service manual for fuel system priming information.



NOTE

To prevent damage to the hand pump priming seals, clean the fuel pump head and priming pump with electrical contact cleaner, Cummins® Part Number 3824510, or equivalent, and compressed air prior to priming the fuel system.

1. After a filter change or running the fuel tank dry, make sure there is fuel in the vehicle fuel tank.



NOTE

It is not necessary to vent air from the high-pressure fuel system before starting the engine. Cranking the engine will prime the fuel system.

2. Unlock the manual priming pump handle by turning it counterclockwise. Pump the primer handle until resistance is felt and the handle can not be pumped anymore (approximately 290 to 340 strokes for dry filters, or 20 to 60 strokes for pre-filled filters).

3. Lock the manual priming pump handle. If installing a new fuel filter on a PX-7, loosen the fuel priming pump knob by rotating it counterclockwise.
4. Crank the engine. If the engine does not start after 30 seconds, turn the key to the OFF position.



NOTE

When the engine does start, it may operate erratically and with increased noise levels for a few minutes. This is a normal condition as air is being removed from the system.



NOTE

It is possible Fault Code 559 may become active after fuel filter replacement due to air introduced in the system. Be sure to run the engine until air is purged and use the recommended Cummins® electronic service tool or equivalent to clear the fault code or take your vehicle to your dealer.

5. Pump the priming pump again, repeating the previous steps until the engine starts.
6. Operate the engine and check for leaks.
7. Operate the priming pump by moving the knob in and out for 150 seconds. During this time the pumping resistance will increase but the full time is required to fully prime the fuel system. Then tighten the knob by rotating it clockwise.



CAUTION

Operate priming pump at a maximum rate of 30 strokes per minute to prevent damage to pump.

8. Check for leakage at the fuel filter cap. Tighten if necessary.



WARNING

Check the fuel filter for signs of leakage. DO NOT smoke or allow an open flame in close proximity. Failure to do so could ignite a fire or cause an explosion which could result in serious injury to you and/or bystanders. Fail-

ure to comply may result in death, personal injury, equipment or property damage.

9. Start the engine and allow it to idle for several minutes. Note that it could take up to 15 seconds of cranking for the engine to start. If the starter is engaged for longer than 20 seconds without starting, additional priming pump actuation may be necessary.



CAUTION

If the engine is cranked excessively, Starter Protection will be triggered and starter engagement will be restricted for 10 minutes.

10. Check the system for leakage while idling. Then turn the engine off and check the system again for leakage.

Cooling System



WARNING

Do not remove the surge tank fill cap on a hot engine. It can cause scalding coolant to spray out and you could be burned. If the engine has been operated within the last 30 minutes, be very careful in removing the radiator cap. Protect face, hands, and arms against escaping fluid and steam by covering the cap with a large, thick rag. Failure to comply may result in death, personal injury, equipment or property damage

**WARNING**

Handle coolant and antifreeze carefully. Ethylene glycol antifreeze is poisonous. Store in dedicated sealable container only, and always keep out of the reach of children. Never remove the filler cap (vertically mounted) on the surge tank while the engine is still hot. Wait until the coolant temperature is below 120°F (50°C). Scalding steam and fluid under pressure may escape and cause serious personal injuries. The pressure cap (horizontally mounted) on the surge tank should never be opened. Failure to comply may result in death, personal injury, equipment or property damage.

Coolant/Antifreeze Condition

Perform these maintenance procedures when indicated by the Preventative Maintenance Schedule.

**NOTE**

Test the engine coolant at least twice per year to determine if the coolant must be replaced. If it is determined that the coolant should be replaced, make sure to flush the coolant system. Contact a PACCAR® Authorized Repair Location for flushing the coolant system.

1. Check the following anti-freeze conditions:
 - Coolant level
 - Freeze point
 - pH level
 - Nitrite level
 - Carboxylate level

Checking Coolant Condition

To ensure the Extended Life Coolant (ELC) in your vehicle always provides maximum protection, perform the following tests:

1. Check the coolant color at every maintenance interval. It should have no cloudiness, floating debris, or oils.

2. Test the freeze point at least twice a year. A refractometer or test strips can be used to measure the protection level.
3. Determine the pH and chemical inhibitor concentration level by using an ELC-specific test kit or test strips.
4. Keep the cooling system full by topping-up using ELC pre-diluted to a 50/50 blend, unless a different ratio of water/antifreeze has been substituted (depending on operating conditions).



CAUTION

Inhibitor concentration level determines corrosion protection. If you are concerned about possible coolant quality, contamination, or mechanical problems, submit a coolant sample to your dealer for analysis. Improper

maintenance may cause coolant degradation and could result in damage to the cooling system and engine components. Consult your dealer or the coolant manufacturer's representative for recommended extended life coolant test kits, test strips, and laboratory sample procedures.

1. Check the following radiator hose conditions:
 - Deterioration/signs of leaking
 - Hose clamp torque

Drive Belts

Radiator Hoses Inspection

Perform this procedure for radiator hoses inspection.

Engine Accessory Drive Belts

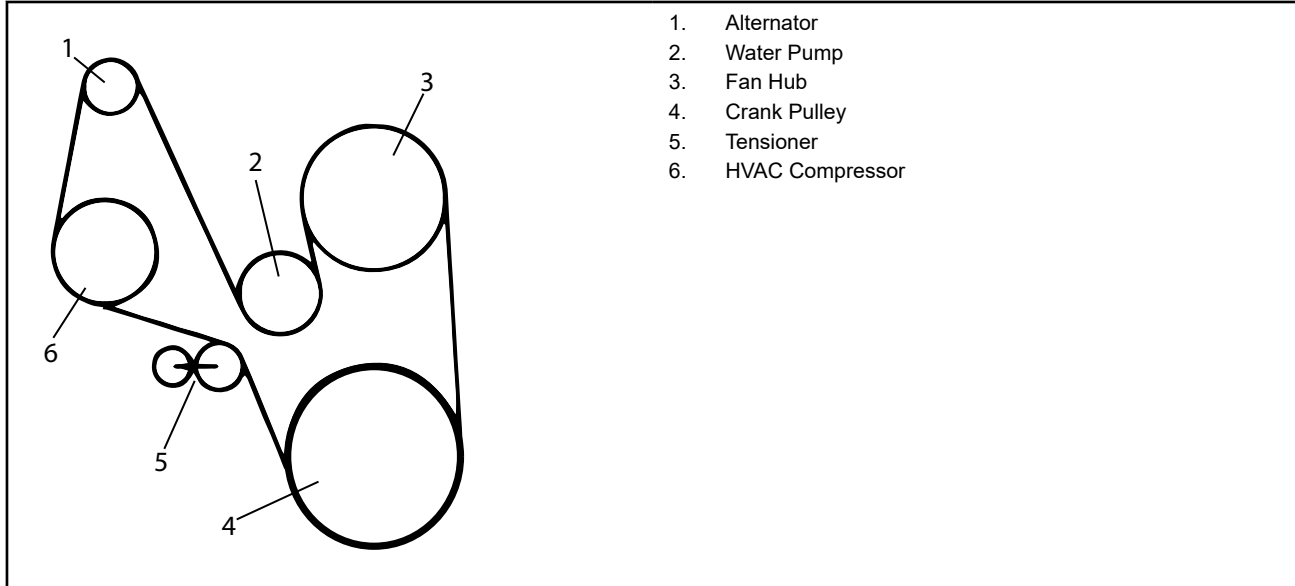



NOTE

Always fit the same type of belts as the ones replaced.

Engine Belt Checks

Perform this maintenance procedure at the mileage or engine hours specified in the Preventative Maintenance Schedule.

1. Inspect the engine belts for the following conditions:
 - Excessive play indicating a seized or failing belt tensioner
 - Cracks, crazing, discoloration, or signs of overheating that may indicate slippage
 - Belt dust or shavings indicating rubbing
 - Frayed or exposed belt threads
 - Signs of animal activity - gnaw marks
 - Belt to pulley misalignment
 - Oil, grease, or coolant contamination
 - Foreign matter pinched between the belt and pulleys or signs of this condition

previously like debris in belt or pulley grooves

2. Listen to the engine on start up or acceleration for any squealing. This is an indication that a belt may be slipping.

If you find signs of premature belt failure, identify, and address the underlying problem as soon as possible and replace the belt making sure that it is installed, aligned, and that the tensioner is working, properly (belt should be taut).

Fan Belt Tensioner (If So Equipped)

Perform this maintenance procedure at the mileage or engine hours specified in the Preventative Maintenance Schedule.

1. Check and correct fan belt tensioner.
 - Mounting bolt torque
 - Tensioner maintains proper belt tension

Fan Belt Removal - If so equipped

Perform this maintenance procedure at the mileage or engine hours specified in the Preventative Maintenance Schedule.

1. Disconnect the electrical ground wire from the battery.

2. Reach between the fan blades and remove the fan blade mounting bolts using a 9/16 in. socket. Remove the fan and store it temporarily where it cannot be damaged.
3. Place a flex-bar with a 15 mm socket on the fastener securing the automatic belt tensioner's roller, as shown in the image.
4. Rotate the flex-bar as shown in the diagram to relieve belt tension.
5. With the belt tensioner pressure relieved, remove the poly V-belt from the pulleys.
 - The tensioner can be temporarily blocked with a 0.16-0.2 in. (4-5 mm) thick pin (bore). This facilitates removal and installation of the poly V-belt.
6. After removing the belt, carefully allow the belt tensioner to spring back to the stop (if it had not been temporarily blocked).
7. Inspect the pulleys for damage, rust, and grease deposits. Clean or replace as necessary.

Fan Belt Installation - If so equipped

Follow the steps below to install the fan belt:

1. Place a new poly V-belt over the pulleys, making certain the belt falls into all the belt pulley grooves. This will ensure proper alignment.



NOTE

When installing the belts DO NOT wrap belt around the tensioner until af-

ter the belt has been wrapped around all other pulleys and idlers.

2. After installing the belt, carefully allow the belt tensioner to spring back to its normal position. If the tensioner had been temporarily blocked, relieve tensioner pressure enough to remove the locking pin, then allow the tensioner to spring back to its normal position.



NOTE

DO NOT reuse nylon patch lock nuts. Replace with new lock nuts when reinstalling parts.

3. Reinstall fan blade using NEW 5/16-18 UNC-2A on Horton fans, or 3/8-24UNF-2A on Borg-Warner fans, with nylon patch lock nuts.
4. Reconnect the electrical ground wire to the battery.

Diesel Exhaust Fluid (DEF) Filter Access

Perform these maintenance procedures according to the Preventative Maintenance Schedule.

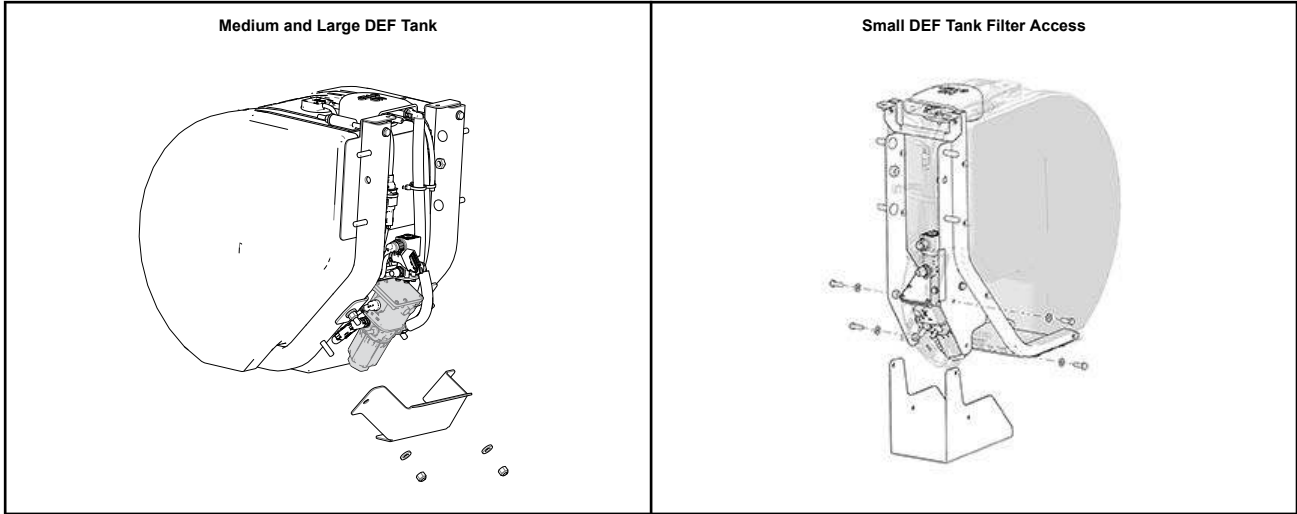

1. Replace the aftertreatment DEF dosing unit (DEF module) filter according to the maintenance schedule.
2. From the bottom of the tank, remove the cover plate by removing the various fasteners holding it on, then allow the cover plate to drop down.

Air Compressor

	<p>WARNING</p>
<p>Failure to carefully complete air brake water draining procedure(s) may leave moisture in the air brake system. Any remaining moisture may degrade or disable brake operation. Failure to</p>	

<p>comply may result in unwarrantable equipment damage, property damage, injury, or death.</p>

**NOTE**

If your vehicle is optioned with two air tanks, drain both. Also drain any reservoirs.

Perform these maintenance procedures according to the Preventative Maintenance Schedule.

1. Bring the engine to operating temperature and allow the air system to fill to air compressor governor cut-out pressure (120-130 psi is typical).
2. If the vehicle has air suspension, make sure that it is at normal driving height.
3. Drain the wet tank, or the first reservoir found in line with the air dryer output, if so equipped.

Air Intake System**Air Cleaner**

Perform these maintenance procedures according to the Preventative Maintenance Schedule.

1. Check and correct for restriction:

- Service filter element when air cleaner restriction gauge (option) locks in the extreme high position.
- Check hose/pipe condition – deterioration/ signs of leaking.
- Check hose clamp torque.

Charge Air Piping

Perform these maintenance procedures according to the Preventative Maintenance Schedule.

1. Check and correct the following charge air piping components:
 - Hose/pipe condition – deterioration/signs of leaking
 - Hose clamps for tightness
 - Clearance to other components

Charge Air Cooler

Perform these maintenance procedures according to the Preventative Maintenance Schedule.

1. Check and correct the following components of the charge air cooler:
 - Cracked tubes or header
 - Clogged fins/tubes
 - Hose/pipe condition – deterioration/signs of leaking

- Hose clamp torque

Charging - Cranking System**Electrical Harness / Cables**

Perform these maintenance procedures according to the Preventative Maintenance Schedule.

1. Check the following electrical components:
 - Inspect for loose connections, corrosion, chafing, and broken retention clips

Batteries, Cables, and Connections

Perform these maintenance procedures according to the Preventative Maintenance Schedule.

1. Check the following electrical components:
 - Condition – electrolyte level, cracks, signs of leaking, overcharging
 - Hold-downs – tightness
 - Battery box mounting bolt – torque

Crankshaft - Vibration Damper

Perform these maintenance procedures according to the Preventative Maintenance Schedule.

1. Inspect for cracks, nicks, or other physical damage.
2. Inspect for loose or missing fasteners.
3. For rubber dampers, inspect for damage to the rubber ring.
4. For viscous dampers, inspect for leaks.

Engine Mounting Bolts

Perform these maintenance procedures when indicated by the Preventative Maintenance Schedule. Check for the following:

1. Inspect both mount and leg fasteners. Check for loose or broken bolts. Replace as necessary.
2. Check mount and leg for fractures, breaks or deformation. Replace as necessary.

3. Check for complete insertion of engine mount. Replace as necessary.



CAUTION

DO NOT re-torque or reuse existing flange head bolts. These bolts are factory set to the specified torque. If bolts are loose or damaged, they must be replaced with the new bolts. Failure to comply may result in equipment or property damage.

Engine Identification

PX Engine EPA Label

The EPA label provides important details about the engine. This label is located on top of the engine valve cover (PX-7) or on the front timing gear cover (PX-9). The engine EPA label must not be changed unless approved by PACCAR.

PX-7 EPA Label Location

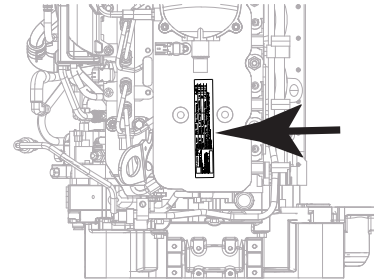

Engine Identification

The engine dataplate contains information specific to that engine. The engine serial number (ESN) and control parts list (CPL) provide information for service and ordering parts.

<p>PACCAR PX-7</p> <p>MANUFACTURED BY CUMMINS INC. Assembled in the U.S.A. 5309099</p> <p>Date of Mfg: XX-XX-XX</p> <p>WARNING: Injury may result and warranty is voided if fuel rate, rpm, or altitudes exceed published maximum values for this model and application.</p>	Engine No. XXXXXXXXX	Ref. No. XXXXXXXXX	Model XXXXXXXX	Fuel rate at adv. HP	XXX $\frac{\text{mm}^3}{\text{stroke}}$	CPL XXXX
	Idle Speed (rpm) XXX	Advertised HP XXX at XXXX rpm	Family XXXXXXXXXXXXXXXX	FEL	EPA	CARB
	Firing Order XXXXXX	Timing- T.D.C. ELECTRONIC	Catalyst No.	XXXX	X.X	X.X
	Valve lash cold (mm) X.XXX Int. X.XXX Exh.	C.I.D./L. XXXX / XX.XX	E.C.S. XXXXXXXXXXXXXXXX	PM	X.X	X.X
<p>IMPORTANT ENGINE INFORMATION: This engine conforms to U.S. EPA and California regulations applicable to XXXX model year New Heavy Duty Engines. This engine is certified to operate on diesel fuel. This engine has a primary intended service application as a medium heavy-duty engine. DELEGATED ASSEMBLY.</p>						

Have the following engine data available when communicating with a PACCAR Authorized Repair Location:

1. Date of manufacture
2. Engine serial number (ESN)
3. Engine model information
4. Fuel rate
5. Control parts list (CPL)
6. Idle speed
7. Valve lash
8. Advertised horsepower and rpm rating
9. Engine displacement

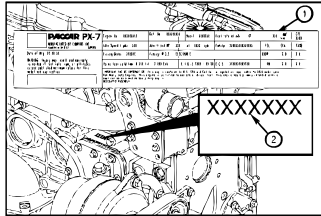

1. Data plate
2. Engine serial number

If the engine dataplate (1) is **NOT** legible, the ESN (2) can be found on the engine block, on top of the lubricating oil cooler housing. Additional engine information is on the electronic control module (ECM) dataplate.

Fuel Injection Pump Dataplate

The Bosch fuel injection pump dataplate is located on the fuel pump.

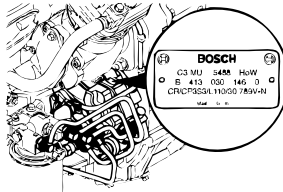

Bosch data plate includes:

- Pump serial number
- PACCAR part number
- Factory code
- Bosch part number
- Date code

Engine Control Module Dataplate

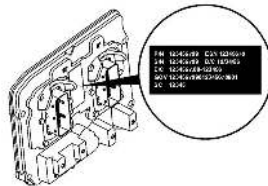

NOTE

Not all engines have ECM data plates.

The engine control module (ECM) dataplate is located on the front of the ECM. The following information is found on the engine control module dataplate:

- ECM part number (PN)
- ECM serial number (SN)
- ECM date code (DC)
- Engine serial number (ESN)
- ECM Code: identifies the software in the ECM.



NOTE

The presence of an ECM data plate depends on the manufacturing plant and the date the engine was manufactured. If an ECM data plate was not installed by the manufacturing plant, calibration data can be found on the engine data plate.

PACCAR Engine Nomenclature

The PACCAR engine nomenclature provides the following information:

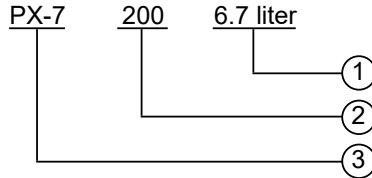

1. Displacement
2. Horsepower rating
3. Engine model

Air Compressor Dataplate



Not all engines are equipped with an air compressor.

The air compressor dataplate is typically located on the side of the air compressor. The dataplate contains the following information to assist in servicing or replacement:

- Part number
- Serial number

- Date code

Variable Geometry Turbocharger Dataplate

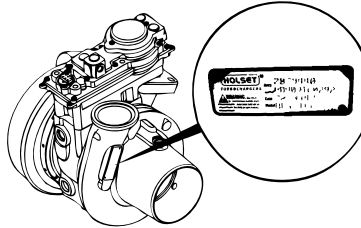

The Holset® variable geometry turbocharger (VGT) dataplate is located on the turbocharger inlet compressor housing. The dataplate contains the following information to assist in servicing or replacement:

- Assembly part number
- Serial number
- Customer number
- Model number



The electronic actuator on the VGT is a serviceable component and has a separate data plate that contains information to assist in servicing or replacement.

Chapter 3 | ENGINE WARRANTY

United States and Canada Engine Warranty..... 77

3

United States and Canada Engine Warranty

Engine Warranty for Standard Duty Applications

Products Warranted

This warranty applies to new PACCAR PX-7 engines sold and used in the United States¹ or Canada and operated in on-highway applications with one exception – there is different warranty coverage for engines used in the fire apparatus truck applications.

The PACCAR PX-7 engine is warranted directly to the first purchaser or first lessee by PACCAR.

Base Engine Warranty

This warranty covers any failures of the engine which result, under normal use and service, from a defect in material or factory workmanship (warrantable failure). This coverage begins on the date of delivery and ends three years, with unlimited

mileage, after the date of delivery of the engine to the first purchaser or first lessee. Engine aftertreatment components included in the PACCAR critical parts list (CPL) and marked with a PACCAR part number are covered under base engine warranty.

Additional coverage is outlined in [Emissions Systems Warranties](#) on page 82.

PACCAR and Owner Responsibilities

PACCAR Responsibilities

PACCAR will pay for all parts and labor needed to repair the damage to the engine resulting from a warrantable failure.

PACCAR will pay for the lubricating oil, antifreeze, filter elements, belts, hoses, and other maintenance items that are not reusable due to the warrantable failure.

PACCAR will pay for reasonable labor costs for engine removal and reinstallation when necessary to repair a warrantable failure.

PACCAR will pay during the base engine warranty period; reasonable costs for

towing a vehicle disabled by a warrantable failure to the nearest authorized repair location. In lieu of the towing expense and in its sole discretion, PACCAR may pay reasonable costs for a mechanic to travel to and from the location of the vehicle when an engine repair is performed at the site of the failure.

Owner Responsibilities

The owner is responsible for the operation and maintenance of the engine as specified in the applicable PACCAR Operator's Manual. The owner is also responsible for providing proof that all recommended maintenance has been performed.

Before the expiration of the applicable warranty, the owner must notify a PACCAR authorized engine dealer or an authorized Cummins Distributor of any warrantable failure and make the engine available for repair by such facility. The warrantable failure must be brought to the attention of a PACCAR authorized engine dealer within 30 days of discovery. Except for engines disabled by a warrantable failure, owner

¹ United States includes American Samoa, the Commonwealth of Northern Mariana Islands, Guam, Puerto Rico, and the U.S. Virgin Islands.

must also deliver the engine to the repair facility.

The owner is responsible for the cost of lubricating oil, antifreeze, filter elements and other maintenance items provided during warranty repairs unless such items are not reusable due to the warrantable failure. The owner is responsible for communication expenses, meals, lodging and similar costs incurred as a result of a warrantable failure.

The owner is responsible for non-engine repairs and for "downtime" expenses, cargo damage, fines, all applicable taxes, all business costs and other losses resulting from a warrantable failure.

The owner is responsible for non-engine repairs and for "downtime" expenses, cargo damage, fines, all applicable taxes, all business costs and other losses resulting from a warrantable failure.

Warranty Limitations - Standard Duty Applications

Your sole and exclusive remedy against PACCAR and the selling dealer arising from your purchase and use of this engine is limited to the repair or replacement of "warrantable failures" at authorized United States and Canadian PACCAR engine dealers or an authorized Cummins

Distributor, or an authorized PACCAR engine facility where applicable, subject to PACCAR's time, mileage, and hour limitations of the engine warranty. The maximum time, mileage and hour limitations of the engine warranty begin running on the date of delivery to the first purchaser or first lessee. The accrued time, mileage, or hours is calculated when the engine is brought into an authorized dealer for correction of warrantable failures.

Failures, other than those resulting from defects in material or factory workmanship, are not covered by this warranty. PACCAR is not responsible for failures or damage resulting from what PACCAR determines to be abuse or neglect, including, but not limited to: damage due to accident; operation without adequate coolants or lubricants; overfueling; overspeeding; lack of maintenance of lubricating, cooling or intake systems; improper storage, starting, warm-up, run-in or shutdown practices; failure to perform regeneration in a timely manner; unauthorized modifications of the engine. PACCAR is also not responsible for failures caused by incorrect oil or fuel or diesel exhaust fluid or by water, dirt or other contaminants in the fuel, oil, or diesel exhaust fluid. Failure of replacement parts

used in repairs due to the above non-warrantable conditions is not warrantable. This warranty does not apply to accessories supplied by the vehicle original equipment manufacturer (OEM) which are covered by the OEM vehicle warranty.

Failures resulting in excessive oil consumption are covered for the duration of the coverage or 100,000 miles (160,000 kilometers) or 6,250 hours from the date of delivery of the engine to the first purchaser or first lessee, whichever occurs first.

Before a claim for excessive oil consumption will be considered, the owner must submit adequate documentation to show that consumption exceeds PACCAR published standards.

Failures of belts and hoses supplied by PACCAR are covered for the first year from the date of delivery of the engine to the first purchaser or first lessee.

Parts used to repair a warrantable failure may be new parts, approved rebuilt parts, or repaired parts. PACCAR is not responsible for failures resulting from the use of parts not approved by PACCAR. A new approved or rebuilt part used to repair a warrantable failure assumes the identity of the part it replaced and is entitled to the remaining coverage hereunder.

PACCAR is not responsible for damage or loss resulting from engine horsepower/ torque upgrades.

PACCAR reserves the right to interrogate electronic control module (ECM) data for purposes of failure analysis.

PACCAR does not warrant antifreeze, lubricants, filters, filter elements, or any other part which is considered a maintenance item. PACCAR does not warrant services to remove ash from the DPF either at or before a regular service interval as indicated in the maintenance schedule or when the system indicates that the DPF requires cleaning unless the service is required as part of a warrantable repair.

PACCAR DOES NOT COVER WEAR OR WEAROUT OF COVERED PARTS. THIS WARRANTY AND THE EMISSION WARRANTY SET FORTH HEREINAFTER ARE THE SOLE WARRANTIES MADE BY PACCAR IN REGARD TO THESE ENGINES.

THIS LIMITED WARRANTY IS THE SOLE WARRANTY MADE BY PACCAR AND THE SELLING DEALER. EXCEPT FOR THE ABOVE LIMITED WARRANTY,

PACCAR AND THE SELLING DEALER MAKE NO OTHER WARRANTIES, EXPRESS OR IMPLIED. PACCAR AND THE SELLING DEALER EXPRESSLY DISCLAIM ANY WARRANTY OF MERCHANTABILITY OR WARRANTY OF FITNESS FOR A PARTICULAR PURPOSE.

PACCAR AND THE SELLING DEALER SHALL NOT BE LIABLE FOR INCIDENTAL OR CONSEQUENTIAL DAMAGES INCLUDING, BUT NOT LIMITED TO: LOSS OF INCOME OR LOST PROFITS; ENGINE OR VEHICLE DOWNTIME; THIRD PARTY DAMAGE, INCLUDING DAMAGE OR LOSS TO OTHER ENGINES, VEHICLES OR PROPERTY, ATTACHMENTS, TRAILERS AND CARGO; LOSS OR DAMAGE TO PERSONAL CONTENTS; COMMUNICATION EXPENSES; LODGING AND/OR MEAL EXPENSES; FINES; APPLICABLE TAXES OR BUSINESS COSTS OR LOSSES; ATTORNEYS' FEES; AND ANY LIABILITY YOU MAY HAVE IN RESPECT TO ANY OTHER PERSON OR ENTITY.

This warranty gives you specific legal rights, and you may also have other rights which vary from state to state.

Engine Warranty for Fire Apparatus Truck Applications

This warranty applies to new PACCAR PX-7 engines sold and used in the United States² or Canada and operated in fire apparatus truck applications.

The PACCAR PX-7 engine is warranted directly to the first purchaser or first lessee by PACCAR.

Base Engine Warranty

The base engine warranty covers any failures of the engine which result, under normal use and service, from a defect in material or factory workmanship (warrantable failure). This coverage begins on the date of delivery to the first purchaser or first lessee and ends after two years, 250,000 miles (400,000 kilometers), or 6,250 engine hours, whichever occurs first.

Engine aftertreatment components included in the PACCAR critical parts list

² United States includes American Samoa, the Commonwealth of Northern Mariana Islands, Guam, Puerto Rico, and the U.S. Virgin Islands.

(CPL) and marked with a PACCAR part number are covered under base engine warranty.

PACCAR and Owner Responsibilities

PACCAR Responsibilities

PACCAR will pay for all parts and labor needed to repair the damage to the engine resulting from a warrantable failure.

PACCAR will pay for the lubricating oil, antifreeze, filter elements, belts, hoses, and other maintenance items that are not reusable due to the warrantable failure. PACCAR will pay for reasonable labor costs for engine removal and reinstallation when necessary to repair a warrantable failure.

PACCAR will pay during the base engine warranty period; reasonable costs for towing a vehicle disabled by a warrantable failure to the nearest authorized repair location. In lieu of the towing expense and in its sole discretion, PACCAR may pay reasonable costs for a mechanic to travel to and from the location of the vehicle when an engine repair is performed at the site of the failure.

Owner Responsibilities

The owner is responsible for the operation and maintenance of the engine as specified in the applicable PACCAR Operator's Manual. The owner is also responsible for providing proof that all recommended maintenance has been performed.

Before the expiration of the applicable warranty, the owner must notify a PACCAR authorized engine dealer or an authorized Cummins Distributor of any warrantable failure and make the engine available for repair by such facility. The warrantable failure must be brought to the attention of a PACCAR authorized engine dealer within 30 days of discovery. Except for engines disabled by a warrantable failure, owner must also deliver the engine to the repair facility.

The owner is responsible for the cost of lubricating oil, antifreeze, filter elements and other maintenance items provided during warranty repairs unless such items are not reusable due to the warrantable failure. The owner is responsible for communication expenses, meals, lodging and similar costs incurred as a result of a warrantable failure.

The owner is responsible for non-engine repairs and for "downtime" expenses,

cargo damage, fines, all applicable taxes, all business costs and other losses resulting from a warrantable failure. The owner is responsible for a \$100 (U.S. Dollars) deductible per each service visit under this plan in the 3rd, 4th, and 5th years of base engine warranty. The deductible will not be charged during the first two years of the base engine warranty.

Warranty Limitations - Fire Truck

Your sole and exclusive remedy against PACCAR and the selling dealer arising from your purchase and use of this engine is limited to the repair or replacement of "warrantable failures" at authorized United States and Canadian PACCAR engine dealers or an authorized Cummins Distributor, or an authorized PACCAR engine facility where applicable, subject to PACCAR's time, mileage, and hour limitations of the engine warranty. The maximum time, mileage and hour limitations of the engine warranty begin running on the date of delivery to the first purchaser or first lessee. The accrued time, mileage, or hours is calculated when the engine is brought into an authorized dealer for correction of warrantable failures.

Failures, other than those resulting from defects in material or factory workmanship, are not covered by this warranty. PACCAR is not responsible for failures or damage resulting from what PACCAR determines to be abuse or neglect, including, but not limited to: damage due to accident; operation without adequate coolants or lubricants; overfueling; overspeeding; lack of maintenance of lubricating, cooling or intake systems; improper storage, starting, warm-up, run-in or shutdown practices; failure to perform regeneration in a timely manner; unauthorized modifications of the engine. PACCAR is also not responsible for failures caused by incorrect oil or fuel or diesel exhaust fluid or by water, dirt or other contaminants in the fuel, oil, or diesel exhaust fluid. Failure of replacement parts used in repairs due to the above non-warrantable conditions is not warrantable. This warranty does not apply to accessories supplied by the vehicle original equipment manufacturer (OEM) which are covered by the OEM vehicle warranty. Failures resulting in excessive oil consumption are covered for the duration of the coverage or 100,000 miles (160,000 kilometers) from the date of delivery of the engine to the first purchaser or first lessee, whichever occurs first. Before a claim for

excessive oil consumption will be considered, the owner must submit adequate documentation to show that consumption exceeds PACCAR published standards.

Failures of belts and hoses supplied by PACCAR are covered for the first year from the date of delivery of the engine to the first purchaser or first lessee.

Parts used to repair a warrantable failure may be new parts, approved rebuilt parts, or repaired parts. PACCAR is not responsible for failures resulting from the use of parts not approved by PACCAR. A new approved or rebuilt part used to repair a warrantable failure assumes the identity of the part it replaced and is entitled to the remaining coverage hereunder.

PACCAR is not responsible for damage or loss resulting from engine horsepower/torque upgrades.

PACCAR reserves the right to interrogate electronic control module (ECM) data for purposes of failure analysis.

PACCAR does not warrant antifreeze, lubricants, filters, filter elements, or any other part which is considered a maintenance item. PACCAR does not warrant services to remove ash from the DPF either at or before a regular service interval as indicated in the maintenance

schedule or when the system indicates that the DPF requires cleaning unless the service is required as part of a warrantable repair.

PACCAR DOES NOT COVER WEAR OR WEAROUT OF COVERED PARTS. THIS WARRANTY AND THE EMISSION WARRANTY SET FORTH HEREINAFTER ARE THE SOLE WARRANTIES MADE BY PACCAR IN REGARD TO THESE ENGINES.

THIS LIMITED WARRANTY IS THE SOLE WARRANTY MADE BY PACCAR AND THE SELLING DEALER. EXCEPT FOR THE ABOVE LIMITED WARRANTY, PACCAR AND THE SELLING DEALER MAKE NO OTHER WARRANTIES, EXPRESS OR IMPLIED. PACCAR AND THE SELLING DEALER EXPRESSLY DISCLAIM ANY WARRANTY OF MERCHANTABILITY OR WARRANTY OF FITNESS FOR A PARTICULAR PURPOSE.

PACCAR AND THE SELLING DEALER SHALL NOT BE LIABLE FOR INCIDENTAL OR CONSEQUENTIAL DAMAGES INCLUDING, BUT NOT LIMITED TO: LOSS OF INCOME OR LOST PROFITS; ENGINE OR VEHICLE DOWNTIME; THIRD PARTY DAMAGE, INCLUDING DAMAGE OR LOSS TO

OTHER ENGINES, VEHICLES OR PROPERTY, ATTACHMENTS, TRAILERS AND CARGO; LOSS OR DAMAGE TO PERSONAL CONTENTS; COMMUNICATION EXPENSES; LODGING AND/OR MEAL EXPENSES; FINES; APPLICABLE TAXES OR BUSINESS COSTS OR LOSSES; ATTORNEYS' FEES; AND ANY LIABILITY YOU MAY HAVE IN RESPECT TO ANY OTHER PERSON OR ENTITY.

This warranty gives you specific legal rights, and you may also have other rights which vary from state to state.

Emissions Systems Warranties

The following emissions system warranties apply to new PACCAR engines marketed by PACCAR that are used in the United States³ and Canada in vehicles designed for transporting persons or property on a street or highway.

Your coverage differs by emissions certification

The emission system warranty applicable to your vehicle will vary depending upon

which emissions certification was optioned at the time of purchase (EPA, CARB, or Legacy). The equipment and maintenance required to meet the differing regulation sets will vary accordingly, and with them - your warranty. The three regulatory standards the states apply are

- the Federal Environmental Protection Agency (EPA)
- the California Air Resources Board (CARB).
- Legacy engines



NOTE

Legacy engines are a provision intended to provide short term flexibilities for manufacturers to certify Heavy Duty Diesel Engines to the current less stringent federal exhaust emission standard for NOx and PM. The engine ID label will indicate which emissions regulation the engine is in compliance with (EPA, CARB, or Legacy).

Base Emissions Warranty Limits	
EPA Cert. Engine	5 years / 100,000 MI / 160,000 KM
CARB Cert. Or Legacy Engines	5 years / 350,000 MI / 560,000 KM

Note that the CARB standard contains all laws and regulations encompassed within the EPA standard as well.

Coverage - EPA and Canada

PACCAR warrants to the first purchaser or first lessee and each subsequent purchaser that the engine is designed, built and equipped so as to conform at the time of sale by PACCAR with all U.S. Federal emission regulations applicable at the time of manufacture and that it is free from defects in material or factory workmanship which would cause it not to meet these regulations within the longer of the following periods: (A) Five years or

³ United States includes American Samoa, the Commonwealth of Northern Mariana Islands, Guam, Puerto Rico, and the U.S. Virgin Islands.

100,000 miles (160,000 kilometers) of operation, whichever occurs first, as measured from the date of delivery of the engine to the first purchaser or first lessee or (B) The base engine warranty. If the vehicle in which the engine is installed is registered in the state of California, a separate [California Emissions Control Warranty Statement](#) on page 84 also applies. See California Emissions Warranty.

Replacing Emissions Related Parts

PACCAR recommends that any service parts used for maintenance, repair, or replacement of emission control systems be new or genuine-approved rebuilt parts and assemblies, and that the engine be serviced by an authorized PACCAR engine dealer. Your vehicle contains air, fuel, and electrical components that may affect engine emission controls. The use of non-genuine aftermarket parts, auxiliary devices or consumables (such as filters, oils, catalysts, additives, and fuels) may result in failures, which will not be covered under the manufacturer's warranty. PACCAR does not evaluate all aftermarket auxiliary devices, accessories or consumables promoted by other manufacturers and their effect on PACCAR

Products. Customers who use such items assume ALL risks related to the effects that result from this usage.

Warranty Limitations - Emissions

Your sole and exclusive remedy against PACCAR and the selling dealer arising from your purchase and use of this engine is limited to the repair or replacement of "warrantable failures" at authorized United States and Canadian PACCAR engine dealers or an authorized Cummins Distributor, or an authorized PACCAR engine facility where applicable, subject to PACCAR's time, mileage, and hour limitations of the engine warranty. The maximum time, mileage and hour limitations of the engine warranty begin running on the date of delivery to the first purchaser or first lessee. The accrued time, mileage, or hours is calculated when the engine is brought into an authorized dealer for correction of warrantable failures.

Failures, other than those resulting from defects in material or factory workmanship, are not covered by this warranty. PACCAR is not responsible for failures or damage resulting from what PACCAR determines to be abuse or neglect, including, but not limited to: damage due to accident;

operation without adequate coolants or lubricants; overfueling; overspeeding; lack of maintenance of lubricating, cooling or intake systems; improper storage, starting, warm-up, run-in or shutdown practices; failure to perform regeneration in a timely manner; unauthorized modifications of the engine. PACCAR is also not responsible for failures caused by incorrect oil or fuel or diesel exhaust fluid or by water, dirt or other contaminants in the fuel, oil, or diesel exhaust fluid. Failure of replacement parts used in repairs due to the above non-warrantable conditions is not warrantable. PACCAR is not responsible for non-engine repairs, downtime expenses, cargo damage, fines, all applicable taxes, all business costs or other losses resulting from a warrantable failure. PACCAR does not warrant antifreeze, lubricants, filters, filter elements, or any other part which is considered a maintenance item. PACCAR does not warrant services to remove ash from the DPF either at or before a regular service interval as indicated in the maintenance schedule or when the system indicates that the DPF requires cleaning unless the service is required as part of a warrantable repair.

THIS LIMITED EMISSION WARRANTY IS THE SOLE WARRANTY MADE BY PACCAR RELATING TO THE EMISSION EQUIPMENT. EXCEPT FOR THE ABOVE LIMITED WARRANTY, PACCAR MAKES NO OTHER WARRANTIES, EXPRESS OR IMPLIED. PACCAR EXPRESSLY DISCLAIMS ANY WARRANTY OF MERCHANTABILITY OR WARRANTY OF FITNESS FOR A PARTICULAR PURPOSE.

PACCAR AND THE SELLING DEALER SHALL NOT BE LIABLE FOR INCIDENTAL OR CONSEQUENTIAL DAMAGES INCLUDING, BUT NOT LIMITED TO: LOSS OF INCOME OR LOST PROFITS; ENGINE OR VEHICLE DOWNTIME; THIRD PARTY DAMAGE, INCLUDING DAMAGE OR LOSS TO OTHER ENGINES, VEHICLES OR PROPERTY, ATTACHMENTS, TRAILERS AND CARGO; LOSS OR DAMAGE TO PERSONAL CONTENTS; COMMUNICATION EXPENSES; LODGING AND/OR MEAL EXPENSES; FINES; APPLICABLE TAXES OR BUSINESS COSTS OR LOSSES; ATTORNEYS' FEES; AND ANY LIABILITY YOU MAY HAVE IN RESPECT TO ANY OTHER PERSON OR ENTITY.

California Emissions Control Warranty Statement

Your Warranty Rights and Obligations

The California Air Resources Board and PACCAR are pleased to explain the emission control system warranty on your 2024 model year diesel engine. In California, new motor-vehicle engines must be designed, built, and equipped to meet the State's stringent anti-smog standards. PACCAR must warrant the emission control system on your diesel engine for the periods of time listed below provided there has been no abuse, neglect or improper maintenance of your diesel engine.

Your emission control system may include parts such as the fuel injection system and engine electronic control module. Also included may be hoses, connectors and other emission related assemblies. If an emission-related part on your engine is found to have a defect in material or factory the part will be repaired or replaced by PACCAR. This is your emission control system defects warranty. Emissions coverage for on-highway applications in the State of California

This emission control system warranty applies to diesel engines (hereafter, engines) certified with the California Air Resources Board beginning with the year 2013, marketed by PACCAR, and registered in California for use in on-highway applications.

Manufacturer's Warranty Coverage

This warranty coverage is provided for five years or 350,000 mi (560,000 km) from the date of delivery of the engine to the first purchaser or first lessee. Where a warrantable condition exists, PACCAR will repair your engine at no cost to you including diagnosis, parts, and labor.

Owner's Warranty Responsibilities

As the engine owner, you are responsible for the performance of the required maintenance listed in your PACCAR operator's manual. You are responsible for presenting your engine to an authorized PACCAR engine dealer or an authorized Cummins Distributor as soon as a problem exists. The warranty repairs should be completed in a reasonable amount of time, not to exceed 30 days.

PACCAR recommends that you retain all receipts covering maintenance on your engine, but PACCAR cannot deny warranty

solely for the lack of receipts or for the failure to ensure the performance of all scheduled maintenance.

As the engine owner, you should also be aware that PACCAR may deny you warranty coverage if your engine or a part has failed due to abuse, neglect, improper maintenance or unapproved modifications. If you have any questions regarding your warranty rights and responsibilities, you should contact Kenworth Truck Company 1-425-828-5000, Peterbilt Motor Company at 1-940-591-4220, or the California Air Resources Board at:

California Air Resources Board, 4001 Iowa Avenue, Riverside, CA 92507

A warranted part which is scheduled for replacement as required maintenance is warranted up to the first scheduled replacement point.

Prior to the expiration of the applicable warranty, the owner must give notice of any warranted emission control failure to an authorized PACCAR engine dealer and deliver the engine to such facility for repair. The owner is responsible for incidental costs such as: communication expenses, meals, lodging incurred by owner or

employees of owner as a result of a warrantable condition.

The owner is responsible for downtime expenses, cargo damage, fines, all applicable taxes, all business costs, and other losses resulting from a warrantable condition.

Emissions Components Statement

State of California emissions components statement for the PACCAR PX-7 engine coverage. This list of emission control parts may be covered by the Emission Control System Warranty under certain failure modes.

Aftertreatment System

- Aftertreatment electroconnections
- Aftertreatment inlet and outlet modules
- Aftertreatment temperature interface module
- Aftertreatment temperature sensors
- Decomposition chamber
- DEF dosing valve
- DEF level sensor
- DEF line heater control relay
- DEF quality sensor

- DEF tank/lines heating elements of heat exchanger and pipe
- DEF tank and lines
- DEF tank heater coolant control valve
- DEF temperature sensors
- Diesel Exhaust Fluid (DEF) dosing unit (Pump)
- Diesel oxidation catalyst
- Diesel particulate filter (except for ash maintenance)
- Diesel particulate filter differential pressure sensor EGR
- Exhaust gas piping from turbocharger out to the last aftertreatment device
- NOx sensors
- SCR catalyst

Air Handling Component

- Ambient air temperature sensor
- Charge air cooler and associated plumbing
- Exhaust gas pressure sensor
- Exhaust manifold
- Grid heater
- Intake manifold

- Intake manifold temperature/pressure sensor
- Throttle actuator/valve
- Turbocharger actuator
- Turbocharger assembly
- Turbocharger compressor intake pressure/temperature sensor
- Turbocharger speed sensor

Base Engine System Component

- Camshaft
- Camshaft valve lobe
- Clean idle sticker
- Coolant temperature sensor
- Crankcase breather
- Engine oil pressure sensor
- Engine speed, position sensor, cam position sensor
- Exhaust valve

Electronic Control System Component

- DEF lamp
- Engine control module
- Engine control module calibration
- OBD connector
- On Board Diagnostic (OBD) Malfunction Indicator Lamp (MIL)

- Wiring harness circuits connected at both ends to emissions warrantable components

Exhaust Gas Recirculation (EGR) System Component

- EGR cooler
- EGR differential pressure sensor
- EGR mixer/venturi
- EGR temperature sensor
- EGR valve

Fueling System

- Fuel injectors
- Fuel lines
- Fuel pressure sensor
- Fuel pump
- Fuel pump actuator
- Secondary fuel pressure/temperature sensor

Replacement Parts

PACCAR recommends that any service parts used for maintenance, repair or replacement of emission control systems be new or genuine PACCAR approved rebuilt parts and assemblies, and that the engine be serviced by an authorized PACCAR engine dealer or an authorized

Cummins Distributor. Your vehicle contains air, fuel, and electrical components that may affect engine emission controls. The use of non-genuine engine or vehicle replacement parts that are not equivalent to the PACCAR engine or OEM vehicle manufacturer's original part may impair the engine and vehicle emissions control system from working or functioning effectively, and may jeopardize your emissions warranty coverage.

The owner may elect to have maintenance, replacement or repair of the emission control parts performed by a facility other than an authorized PACCAR engine dealer or an authorized Cummins Distributor and may elect to use parts other than new or genuine approved rebuilt parts and assemblies for such maintenance, replacement or repair; however, the cost of such service or parts and subsequent failures resulting from such service or parts will not be covered under this emission control system warranty, except for "[Emergency Repairs](#)" on page 87."

PACCAR Responsibilities

The warranty coverage begins when the engine is delivered to the first purchaser or first lessee. Repairs and service will be performed by any authorized PACCAR

engine dealer or an authorized Cummins Distributor using new or genuine PACCAR approved rebuilt parts and assemblies. PACCAR will repair any of the emission control parts found by PACCAR to be defective without charge for parts or labor (including diagnosis which results in determination that there has been a failure of a warranted emission control part).

Emergency Repairs

In the case of an emergency where an authorized PACCAR engine dealer or an authorized Cummins Distributor is not available, repairs may be performed by any available repair location or by any individual using any replacement parts. A part not being available within 30 days or a repair not being complete within 30 days constitutes an emergency. PACCAR will reimburse the owner for expenses (including diagnosis), not to exceed the manufacturers suggested retail price for all warranted parts replaced and labor charges based on the manufacturers recommended time allowance for the warranty repair and the geographically appropriate hourly labor rate. Replaced parts and paid invoices must be presented at an authorized PACCAR engine dealer or an authorized Cummins

Distributor as a condition of reimbursement for emergency repairs not performed by an authorized PACCAR engine dealer or an authorized Cummins Distributor.

Warranty Limitations

Your sole and exclusive remedy against PACCAR and the selling dealer arising from your purchase and use of this engine is limited to the repair or replacement of “warrantable failures” at authorized United States and Canadian PACCAR engine dealers or an authorized Cummins Distributor, or an authorized PACCAR engine facility where applicable, subject to PACCAR’s time, mileage, and hour limitations of the engine warranty. The maximum time, mileage and hour limitations of the engine warranty begin running on the date of delivery to the first purchaser or first lessee. The accrued time, mileage, or hours is calculated when the engine is brought into an authorized dealer for correction of warrantable failures.

Failures, other than those resulting from defects in material or factory workmanship, are not covered by this warranty. PACCAR is not responsible for failures or damage resulting from what PACCAR determines to be abuse or neglect, including, but not

limited to: damage due to accident; operation without adequate coolants or lubricants; overfueling; overspeeding; lack of maintenance of lubricating, cooling or intake systems; improper storage, starting, warm-up, run-in or shutdown practices; failure to perform regeneration in a timely manner; unauthorized modifications of the engine. PACCAR is also not responsible for failures caused by incorrect oil or fuel or diesel exhaust fluid or by water, dirt or other contaminants in the fuel, oil, or diesel exhaust fluid. Failure of replacement parts used in repairs due to the above non-warrantable conditions is not warrantable. PACCAR is not responsible for failures resulting from improper repair or the use of parts which are not genuine PACCAR approved parts. PACCAR is not responsible for the material and labor costs of emission control parts and assemblies replaced during Scheduled Maintenance of the engine as specified in PACCAR Operator’s Manuals. PACCAR does not warrant antifreeze, lubricants, filters, filter elements, or any other part which is considered a maintenance item. PACCAR does not warrant services to remove ash from the DPF either at or before a regular service interval as indicated in the maintenance

3

schedule or when the system indicates that the DPF requires cleaning unless the service is required as part of a warrantable repair.

THIS WARRANTY, TOGETHER WITH THE EXPRESS COMMERCIAL WARRANTIES ARE THE SOLE WARRANTIES MADE BY PACCAR IN REGARD TO THESE ENGINES.

THIS LIMITED EMISSIONS WARRANTY IS THE SOLE WARRANTY MADE BY PACCAR AND THE SELLING DEALER. EXCEPT FOR THE ABOVE LIMITED WARRANTY, PACCAR AND THE SELLING DEALER MAKE NO OTHER WARRANTIES, EXPRESS OR IMPLIED. PACCAR AND THE SELLING DEALER EXPRESSLY DISCLAIM ANY WARRANTY OF MERCHANTABILITY OR WARRANTY OF FITNESS FOR A PARTICULAR PURPOSE.

PACCAR AND THE SELLING DEALER SHALL NOT BE LIABLE FOR INCIDENTAL OR CONSEQUENTIAL DAMAGES INCLUDING, BUT NOT LIMITED TO: LOSS OF INCOME OR LOST PROFITS; ENGINE OR VEHICLE DOWNTIME; THIRD PARTY DAMAGE, INCLUDING DAMAGE OR LOSS TO OTHER ENGINES, VEHICLES OR PROPERTY, ATTACHMENTS, TRAILERS

AND CARGO; LOSS OR DAMAGE TO PERSONAL CONTENTS; COMMUNICATION EXPENSES; LODGING AND/OR MEAL EXPENSES; FINES; APPLICABLE TAXES OR BUSINESS COSTS OR LOSSES; ATTORNEYS' FEES; AND ANY LIABILITY YOU MAY HAVE IN RESPECT TO ANY OTHER PERSON OR ENTITY.

Index

A

Accessory Drive [66](#)
Additives to Cooling System [47](#)
Aftertreatment Exhaust Piping [35](#)
Air Cleaner [71](#)
Air Compressor [70](#)
Air Intake Piping [35](#)
Antifreeze [65](#)

B

Batteries, Cables, and Connections [71](#)
Belt Routing [66](#)
Belts [66](#)
Biodiesel [51](#), [59](#)

C

Charge Air Cooler [71](#)
Charge Air Piping [71](#)
Chassis Fuel Filter / Water Separator [34](#)
Check Engine Lamp Turns On [11](#)
Checking Coolant Condition [65](#)
Cleaning the Engine [33](#)
Cold Weather Starting [21](#)
Coolant Level [34](#)
Cooling Fan [34](#)
Cooling System [64](#)
Cooling System Overheating [11](#)
Crankshaft - Vibration Damper [72](#)

D

Diesel Exhaust Fluid [35](#)
Diesel Exhaust Fluid (DEF) Lamp [16](#)
Diesel Exhaust Fluid filter access [69](#)
Diesel Fuel [59](#)
Drive Belts [66](#)
Driving [18](#)

E

ELC [65](#)
Electrical Harness / Cables [71](#)
Electromagnetic Interference [25](#)
Engine Belt Checks [68](#)
Engine Braking System [16](#)
Engine Coolant Specifications [49](#)
Engine Cooling Recommendations and Specifications [47](#)
Engine is overheating [11](#)
Engine Lubricating Oil Recommendations and Specifications [40](#)
Engine Lubrication and Filter Intervals [43](#)
Engine Maintenance [33](#)
Engine Mounting Bolts [72](#)
Engine Oil [56](#)
Engine Oil Capacities and Pressures [42](#)
Engine Oil Filter [56](#)
Engine Oil Filter Specifications [40](#)
Engine Oil Level [55](#)
Engine Oil Pressure Lamp Turns On [10](#)
Engine Operating Range [23](#)
Engine Shutdown [25](#)
Engine Specifications for operator manual [39](#)
Engine Wait-To-Start Lamp [16](#)

Engine Warning Lamps [13](#)
Engine, Check Engine [14](#)
Engine, identification, PX, PX-7, PX-9, PX7, PX9, data, plate, ESN, serial, number, no, num [72](#)
Engine, identification, PX, PX-7, PX-9, PX7, PX9, horsepower, horse, power, hp, displacement, rating, model, nomenclature [75](#)
Exhaust Brake [16](#)
Extended Life Coolant [50](#), [65](#)

F

Fan Belt Tensioner [68](#)
Filters [56](#), [58](#), [59](#), [61](#)
Forward [6](#)
Fuel Filter [51](#), [59](#)
Fuel Filter / Water Separator [34](#)
Fuel Filter Installation [62](#)
Fuel Filter Removal [61](#)
Fuel filter, Water, Drain [60](#)
Fuel Gelling [53](#)
Fuel Recommendations [51](#)

G

General Safety Instructions [7](#)

H

High Exhaust System Temperature (HEST)

Warning Light [15](#)

I

Idling in Freezing Temperatures, Extended [24](#)
Illustrations [7](#)
Install Fuel Filter [62](#)

M

Maintenance Schedule Intervals [36](#)
MIL, See Malfunction Indicator Light (MIL)

N

Normal Starting Procedure [21](#)

O

oil filter [57](#)
Oil Filter Removal [56](#), [58](#)
Oil Filter Removal Preparation [56](#)
Oil Level Indication on Dipstick [56](#)
Operating on Grades and Dry Pavement [27](#)
Operating on Level and Dry Pavement [26](#)
Operating the Engine [23](#)

P

Poly V Fan Belt Install [69](#)
Poly V-belt and Fan Drive Belts [68](#)
Preventative Maintenance Schedule [36](#)
PX Cooling System Maintenance [47](#)

R

Radiator Hoses [66](#)
Recommendations and Specifications [53](#)
Recommendations to avoid fuel gelling in cold temperatures [53](#)
Remove Fuel Filter [61](#)
Remove Oil filter [56](#)
Remove Oil Filter [58](#)
Replacing Emissions Related Parts [83](#)

Roadside Assistance [9](#)

S

Safety Messages and Notes [5](#)

Starting Procedure After Extended Shutdown or Oil Change [22](#)

Stop Engine Lamp [10, 14](#)

T

Topping Up the Engine Oil [56](#)

U

ULSD [51](#)

Ultra-Low Sulfur Diesel [51](#)

Using this Manual [5](#)

V

Visual Inspection of Engine [34](#)

W

Warning Lights

Diesel Particulate Filter (DPF) [14](#)

High Exhaust System Temperature (HEST) [15](#)

Malfunction Indicator Light (MIL) [30](#)

Warranty and the Use of Biodiesel Fuel [52](#)



WARNING

Breathing diesel engine exhaust exposes you to chemicals known to the State of California to cause cancer and birth defects or other reproductive harm.

- Always start and operate the engine in a well-ventilated area.
- If in an enclosed area, vent the exhaust to the outside.
- Do not modify or tamper with the exhaust system.
- Do not idle the engine except as necessary.

For more information go to www.P65warnings.ca.gov/diesel.

PACCAR^{inc}

P.O. Box 1518
Bellevue, WA 98009

Y53-1183-1K1